



Cabada

EXCLUSIVAS PARA LA CONSTRUCCIÓN

TARIFA 2024

01 - ABRIL



OFICINA: C/CARACAS, Nº10 (36203) VIGO – TFNOS. 986421617 / 986420560

ALMACEN VINCIOS: RUA OUTEIRO DO FERRO – POLIG. A PASAXE – VINCIOS (GONDOMAR) – TFNO: 986467001

ALMACEN PONTEAREAS: LOMBA, 81 – AREAS (PONTEAREAS) – TFNO: 986640283

Mail: info@cabadacomercial.com / tecnicos@cabadacomercial.com / ponteareas@cabadacomercial.com

Web: www.cabadacomercial.com

PLADUR[®]

VELUX[®]
La ventana para tejados

Euronit[®]

ALGISS[®]

Tejas
Verea
desde 1967

Riwega[®]

Onduline[®]

UMBELINO MONTEIRO
COBERTURAS PARA A VIDA

CERANOR

ChovA
IMPERMEABILIZACIÓN Y AISLAMIENTO

BMI

polynum

PROPAMSA[®]
EXPERIENCIA Y TECNOLOGÍA

ARLITA Leca[®]

URSA

HORMADISA

Quilosa[®]
PROFESSIONAL

ESYEDEBRO

THU

DAKOZA

PRU

kriket

ASTURMADI
DOORS

mora
CERÁMICAS



INDICE

➤	PRODUCTOS CERÁMICOS	Pág. 3 – 10
	■ TEJA MIXTA BMI.....	Pág. 3
	■ TEJA PLANA BMI.....	Pág. 4
	■ TEJA UMBELINO MONTEIRO.....	Pág. 5
	■ TEJA VEREA.....	Pág. 6
	■ LADRILLO CARA VISTA – ICD, LA MORA -.....	Pág. 7
	■ LADRILLOS.....	Pág. 9
	■ TERMOBRICK.....	Pág. 10
➤	CUBIERTAS	Pág. 11 – 21
	■ PLACA FIBROCEMENTO (Gran onda, Minionda, Mixta).....	Pág. 11
	■ ONDULINE BT.....	Pág. 12
	■ ONDUCOBER, ONDUVILLA Y ACCESORIOS.....	Pág. 13
	■ ACCESORIOS ONDULINE.....	Pág. 14
	■ PANEL SANDWICH ONDUTHERM (A CONSULTAR)	Pág. 15
	■ PLÁSTICOS – ONDULINE -.....	Pág. 16-17
	■ ACCESORIOS CUBIERTAS.....	Pág. 18-20
	■ PANEL CUBIERTA.....	Pág. 21
➤	FORJADOS	Pág. 22 – 28
	■ FORJADO SANITARIO FERRACÍN.....	Pág. 22
	■ TUBOS ENCOFRADO, MALLA ELECTROSOLDADA, FIBRA PP.....	Pág. 23
	■ VIGUETAS ARMADAS (A CONSULTAR)	Pág. 24-25
	■ BOVEDILLAS (Hormigón, arlita, poliestireno y cerámica).....	Pág. 26
	■ ACCESORIOS FORJADOS – Separadores y seguridad –.....	Pág. 27
	■ VIGUETAS PRETENSADAS, DINTELES Y POSTES RECTOS.....	Pág. 28
➤	PREFABRICADOS DE HORMIGÓN	Pág. 29 – 33
	■ POSTES.....	Pág. 29
	■ AROS Y TAPAS DE POZO, TAPAS DE NICHOS.....	Pág. 30
	■ BLOQUE CIERRE, BLOQUE MURO, BORDILLO DE JARDÍN Y ARQUETAS DE CEMENTO.....	Pág. 31
	■ FOSAS SÉPTICAS (A CONSULTAR)	Pág. 32-33
➤	AISLAMIENTOS	Pág. 34 – 38
	■ POLIESTIRENO EXTRUIDO – CHOVAFOAM –.....	Pág. 34
	■ LANA MINERAL – URSA –, LANA DE ROCA – ROCKWOOL –.....	Pág. 35
	■ AISL. REFLECTIVO – POLYNUM - ARLITA Y PERLITA.....	Pág. 36
	■ POLIESTIRENO EXPANDIDO.....	Pág. 37
	■ ACCESORIOS AISLAMIENTO.....	Pág. 38
➤	IMPERMEABILIZACIÓN Y AISLAM. – ASFALTOS CHOVA –	Pág. 39 – 43
	■ POLITABER, CHOVAPLAST, RAPID-BRIC Y CHOVIPOL.....	Pág. 39
	■ TEGOLA, IMPRIMACIONES Y EMULSIONES, SLURRYS, Y ACCESORIOS.....	Pág. 40
	■ CHOVATEC ANTIGOTERAS, MALLA, LAMINA DRENANTE, GEOFIM CHOVA TERM (lámina con poliest. Extruido).....	Pág. 41
	■ CHOVASTAR.....	Pág. 42
	■ AISLAMIENTO ACÚSTICO RUIDO AÉREO, RUIDO DE IMPACTO.....	Pág. 43
➤	YESOS, ESCAYOLAS Y CEMENTO	Pág. 44
	■ YESOS Y ESCAYOLAS – ESYEDEBRO Y ALGISS–,	
	■ MALLA YESO Y MALLA REVEST EXTERIOR	
➤	PRODUCTOS DE ESCAYOLA	Pág. 45
	■ PLANCHA LISA, BALDAS, MOLDURAS, TECHO DESMONTABLE ESPARTO (Mezcla y Sisal)	



INDICE

➤	CEMENTOS COLA Y MORTEROS PROPAMSA	Pág. 46 – 47
	■ NIVELANTES, ADHESIVOS, JUNTAS, RE VAT CAL	Pág. 46
	■ MORTEROS FACHADA E INTERIORES, AISTERM, REPARACIÓN HORMIGÓN, ANCLAJES Y MONTAJES, IMPERMEABILIZACIÓN E IMPRIMACIÓN	Pág. 47
➤	PRODUCTOS DRENAJE Y DESAGÜE	Pág. 48 – 49
	■ ARQUETA, REJILLA REFORZADA, MARCO REFORZADO, TAPADERA REFORZADA, TAPADERA REBAJADA, PROLONGACIÓN Y PLACA SIFÓNICA	Pág. 48
	■ CANALETAS	Pág. 49
	■ BOCA DESAGÜE, ANGULAR DESAGÜE	Pág. 49
➤	ESCALERA ESCAMOTEABLE Y CONTRAMARCOS	Pág. 50 - 51
	■ ESCALERA ESCAMOTEABLE METÁLICA	Pág. 50
	■ CONTRAMARCOS KRIKET	Pág. 51
➤	PUERTAS	Pág. 52
	■ PUERTAS CORTAFUEGO Y ACCESORIOS	
	■ PUERTAS MULTIUSO	
➤	LISTELOS Y PERFILES	Pág. 53
	■ ESQUINERO PLÁSTICOS, ESQUINERO MONOCAPA	
	■ LISTELO CUADRADO, LISTELO ALUMINO EN T	
	■ GUARDAVIVO ALUMINIO	
	■ ANGULO PVC, ANGULO VIERTEAGUAS	
➤	ACCESORIOS Y HERRAMIENTAS	Pág. 54 – 56
	■ ADAPTADOR TOPE PROFUNDIDAD	Pág. 54
	■ AISLADOR ACÚSTICO	Pág. 54
	■ CAZOLETA NIVELADORA	Pág. 54
	■ ALCOTANA	Pág. 54
	■ CARRIL MADERA, MEDIA CAÑA Y DENTADO	Pág. 54
	■ TIJERA PARA CHAPA, SERRUCHO Y SIERRA CONTORNEAR	Pág. 54
	■ PUNTAS ACERO	Pág. 54
	■ BROCAS SDS-PLUS	Pág. 54
	■ REGLAS	Pág. 54
	■ CEPILLO 8 CUCHILLAS	Pág. 55
	■ ESCOFINA PLACAS Y REPUESTO	Pág. 55
	■ RASPILLAS (CUCHILLAS)	Pág. 55
	■ ESPATULAS	Pág. 55
	■ LLANAS	Pág. 55
	■ PALETA	Pág. 55
	■ FIJACIÓN RÁPIDA OMEGA	Pág. 56
	■ REMACHE FLOR	Pág. 56
	■ TACO PARAGÜAS	Pág. 56
	■ TACO LATÓN	Pág. 56
	■ TACO NYLÓN	Pág. 56
	■ TACO RÁPIDO CON COLLARÍN	Pág. 56
	■ TUERCA HEXAGONAL	Pág. 56
	■ VARILLA ROSCADA	Pág. 56
	■ ARANDELA DE HIERRO	Pág. 56
	■ GRAPA VIGUETA PARA VARILLA	Pág. 56
➤	ESPUMAS QUILOSA	ANEXO – I –
➤	ÁRIDOS Y MORTERO MAMPOSTERÍA	ANEXO – II –
➤	PIEDRAS	ANEXO – III –



TARIFA DE PRECIOS



ARTICULOS			PVP* (€/UD)
TEJA MIXTA S10			
ROJA	458X282 3.800 kg PALET: 240 uds/palet 10,5 ud/m2 Rastrel: 40,1-40,3 cm		1,56
TEJA MIXTA DUNA			
ROJA	454x288 3.900 kg PALET: 216 uds/palet 10,5 ud/m2 Rastrel: 39,3-40,1 cm		1,70
MARRÓN			2,08
PIEZAS ESPECIALES			
CABALLETE UNIVERSAL	COLORES	2,5 UD/ML	7,25
CABALLETE 3 VÍAS	COLORES		34,10
FINAL LIMATESA	COLORES		18,60
TAPA DE CABALLETE	COLORES		35,45
CUÑA	COLORES	4,5 UD/ML	2,80
REMATE LATERAL UNIVERSAL	COLORES	2,4 UD/ML	7,05
REMATE LATERAL DCHO/IZQ	COLORES	2,5 UD/ML	7,15
TEJA SOPORTE CHIMENEA	COLORES		55,20
CHIMENEA	COLORES		58,95
MEDIA TEJA	COLORES		5,10
TEJA VENTILADORA + REJILLA	COLORES	0,1 UD/m2	19,25

DUNA
MARRÓN

ARTICULOS			PVP* (€/UD)
TEJA MIXTA MERIDIONAL (KLINKER)			
ROJA	424X258 3.150 kg PALET: 320 uds/palet 12,5 ud/m2 Rastrel: aprox 36,5		1,86
MAGMA			2,08
ÉBANO			2,26
PIEZAS ESPECIALES			
CABALLETE UNIVERSAL	COLORES	2,5 UD/ML	9,15
CABALLETE 3 VÍAS	COLORES		70,30
FINAL LIMATESA	COLORES		36,25
TAPA DE CABALLETE	COLORES		35,45
CUÑA	COLORES	4,5 UD/ML	3,80
REMATE LATERAL UNIVERSAL	COLORES	2,4 UD/ML	9,60
REMATE LATERAL DCHO/IZQ	COLORES	2,5 UD/ML	9,25
TEJA SOPORTE CHIMENEA	COLORES		64,35
CHIMENEA	COLORES		66,10
MEDIA TEJA	COLORES		5,60
TEJA VENTILADORA + REJILLA	COLORES	0,1 UD/m2	32,60



ROJO



ÉBANO



* IVA NO INCLUIDO

feb-24

OFICINA: C/CARACAS, Nº10 (36203) VIGO – TFNOS. 986421617 / 986420560 FAX: 986483297
 ALMACEN VINCIOS: RUA OUTEIRO DO FERRO – POLIG. A PASAXE – VINCIOS (GONDOMAR) – TFNO: 986467001
 ALMACEN PONTEAREAS: LOMBA, 81 – AREAS (PONTEAREAS) – TFNO: 986640283
 Mail: info@cabadacomercial.com / tecnicos@cabadacomercial.com / ponteareas@cabadacomercial.com
 Web: www.cabadacomercial.com



TARIFA DE PRECIOS



ARTICULOS			PVP* (€/UD)
TEJA MARSELLA COLLADO			
ROJA	432x262 3.300 kg PALET: 210 uds/palet 12-13,5 ud/m2 Rastrel: 33-37 cm		1,82
PIEZAS ESPECIALES			
CABALLETE CLÁSICO	COLORES	240 uds/palet	7,25
FINAL LIMATESA	COLORES		18,60
TAPÓN CABALLETE	COLORES		35,45
REMATE LATERAL UNIVERSAL	COLORES	284 uds/palet	7,05
TEJA DE VENTILACIÓN + REJILLA	COLORES		20,20
TEJA SOPORTE CHIMENEA	COLORES		53,55
CHIMENEA	COLORES		58,95
TEJA PLANA LISA – LÓGICA PLANA			
COLORES (ébano, galena y marrón)	Colores: 454x283 4.550 kg PALET: 210 uds/palet 11 ud/m2 Rastrel(máximo): Roja 37,5 cm Colores: 37cm		2,97
PIEZAS ESPECIALES			
MEDIA TEJA PLANA	COLORES	210 uds/palet	5,80
CABALLETE UNIVERSAL	COLORES	192 uds/palet	9,15
CABALLETE PLANO	COLORES	144 uds/palet	11,05
TAPON CABALLETE UNIVERSAL	COLORES	284 uds/palet	37,30
TAPÓN CABALLETE PLANO	COLORES		
REMATE LATERAL UNIVERSAL	COLORES	284 uds/palet	9,60
REMATE LATERAL DCHO/IZQ	COLORES	64 uds/palet	7,85
TEJA VENTILADORA + REJILLA	COLORES		31,85
TEJA SOPORTE CHIMENEA	COLORES		64,35
TAPA SALIDA DE HUMOS	COLORES		16,20



MARSELLA

LÓGICA
PLANA

* IVA NO INCLUIDO

feb-24

OFICINA: C/CARACAS, Nº10 (36203) VIGO – TFNOS. 986421617 / 986420560 FAX: 986483297
 ALMACEN VINCIOS: RUA OUTEIRO DO FERRO – POLIG. A PASAXE – VINCIOS (GONDOMAR) – TFNO: 986467001
 ALMACEN PONTEAREAS: LOMBA, 81 – AREAS (PONTEAREAS) – TFNO: 986640283
 Mail: info@cabadacomercial.com / tecnicos@cabadacomercial.com / ponteareas@cabadacomercial.com
 Web: www.cabadacomercial.com

TARIFA DE PRECIOS

ARTICULOS			PVP* (€/UD)
TEJA MIXTA ADVANCE PREMIUM			
TEJA 	ROJO	445X249 mm	1,35
	CASTAÑA / ECLIPSE	13 ud/m ²	2,20
	COLORES	Rastrel 38 cm 288 ud/palet	1,78
CUMIO	ROJO	2.5 ud/ml	2,82
	COLORES		4,56
CUÑA	ROJO	10 ud/ml	0,83
	COLORES		1,29
MEDIA TEJA	ROJO		3,42
	COLORES		4,78
REMATE LATERAL	ROJO	2.5 ud/ml	6,72
	COLORES		11,08
CUMIO TRES VÍAS (3H MACHO / HEMBRA)	ROJO		15,75
	COLORES		25,49
INICIO CABALLETE	ROJO		11,83
	COLORES		19,34
TEJA VENTILADORA + REJILLA	ROJO		9,68
	COLORES		14,53
TAPÓN CUMBRERA (FRONTON)	ROJO		14,56
	COLORES		18,33
TEJA TRANSITO	ROJO		17,66
TEJA SOPORTE CHIMENEA	ROJO		41,55
CHIMENEA (cónica / cilíndrica)	ROJO		54,15

TEJA MARSELLA ADVANCE PREMIUM			
TEJA 	ROJO	445 x 245 mm	1,35
	ROJA ENVEJECIDA	13 ud/m ²	1,78
	ECLIPSE	Rastrel 38 cm 320 ud/palet	2,20
CUMIO	ROJO	2.5 ud/ml	2,82
	COLORES		4,56
REMATE LATERAL	ROJO	2.5 ud/ml	6,72
	COLORES		11,08
CUMIO TRES VÍAS (3H MACHO / HEMBRA)	ROJO		15,75
	COLORES		25,49
INICIO CABALLETE	ROJO		11,83
	COLORES		19,34
MEDIA TEJA	ROJO		3,97
	COLORES		7,22
TEJA VENTILADORA Y TRÁNSITO	ROJO		18,41
	COLORES		24,18

TEJA CURVA			
TEJA 	ROJO	445X158	0,70
	COLORES	30 ud/m ² 630 ud/palet	0,96
CUMIO	ROJO	2.8 ud/ml	2,48
	COLORES		4,58
CUÑA	ROJO	10 ud/ml	0,70
	COLORES		1,25
TEJA VENTILADORA	ROJO		8,00
	COLORES		14,76
TEJA DE TRANSITO	ROJO		13,65

* TEJA VIDRIADA A CONSULTAR *

* IVA NO INCLUIDO

oct-22

OFICINA: C/CARACAS, N°10 (36203) VIGO – TFNOS. 986421617 / 986420560
 ALMACEN VINCIOS: RUA OUTEIRO DO FERRO – POLIG. A PASAXE – VINCIOS (GONDOMAR) – TFNO: 986467001
 ALMACEN PONTEAREAS: LOMBA, 81 – AREAS (PONTEAREAS) – TFNO: 986640283
 Mail: info@cabadacomercial.com / tecnicos@cabadacomercial.com / ponteareas@cabadacomercial.com
 Web: www.cabadacomercial.com



TARIFA DE PRECIOS



ARTICULO	ROJA	MARRÓN	ENVEJECIDA	AÑEJA	JACOBEA	GRAFITO
TEJA CURVA	PVP €/ud	PVP €/ud	PVP €/ud	PVP €/ud	PVP €/ud	PVP €/ud
TEJA 40X15 (Soporte placa 177, 35 ud/m2, 624 ud/palet)	0,47	0,56	0,59	0,64	0,64	0,66
TEJA 40X20 (Soporte placa 230/BT235, 25 ud/m2, 384 ud/palet)	0,68		-	-	-	-
CUMIO 50X21	1,05	1,20	-	-	1,23	-
TEJA ALERO 40X15	0,58	0,66	0,67	0,72	0,74	0,73
REMATE LATERAL RECTO DCHO/IZQ	4,46	5,84	5,84	5,84	5,84	5,84
REMATE LATERAL DOBLE CURVO	4,46	5,84	5,84	5,84	5,84	5,84
CUÑA PEQUEÑA	1,46	1,90	1,90	1,90	1,90	1,90
TAPÓN CUMBRERA	17,64	28,97	28,97	28,97	28,97	28,97
VENTILADORA	9,07	12,09	12,09	12,09	12,09	12,09

ARTICULO	ROJA	GRAFITO	SLATE	SLATE TX
	PVP €/ud	PVP €/ud	PVP €/ud	PVP €/ud
TEJA PLANA				
TEJA 40X25 (12.5 ud/m2, 384/288 ud/palet)	3,30	3,49	3,62	3,74
CUMIO	2,55	3,24	3,24	3,24
TAPON CUMBRERA	17,64	28,97	28,97	28,97
REMATE LATERAL	2,44	3,26	3,26	3,26



PALETS (se abonarán a su devolución)

2,50 €/UD



REMATE LATERAL DOBLE CURVO



Teja Ventiladora



Teja Alero

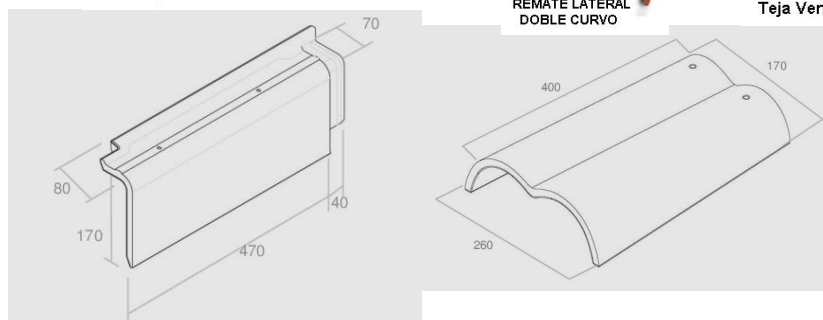

CUMIO PLANO



CUÑA

NOTA: CONSULTAR ACCESORIOS PARA CUBIERTA

* IVA NO INCLUIDO

may-23



TARIFA DE PRECIOS

***Hasta fin de existencias**

ARTICULOS			PVP* (€/UD)
LADRILLO MANUAL CUERO	21,5X10X6,5		1,10
LADRILLO CARA VISTA 5 HIDROFUGADO – LISO – (Raspado aumentaría 0.01 €/ud)			
SAGRA		Medida: 240x114x48 66 ud/m2 408 ud/palet Peso: 1,55 kg	0,24*
MARFIL			0,25*
MARRON CLARO / OSCURO			0,27*
GRANA / DUNA / VISÓN			0,26*
ARENA / GREDA			0,27*
ÉBANO			0,29*
PARADORES			
AVELLANA	Medida: 240x115x38		0,31*



PARADORES - AVELLANA

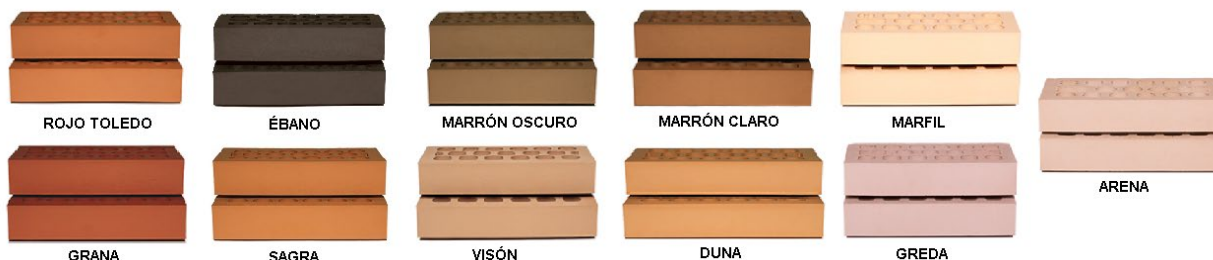

		LADRILLOS LA MORA			
GRES ROJO (456 uds/palet)	23,6X11,3X4,8			CONSULTAR	
GRES VULCANO	23,6X11,3X4,8			CONSULTAR	
GRES BACO	23,6X11,3X4,8			CONSULTAR	
CLINKER NEGRO	23,6X11,3X4,8			CONSULTAR	
CLINKER CENIZA	23,6X11,3X4,8			CONSULTAR	
CLINKER GRIS	23,6X11,3X4,8			CONSULTAR	
CLINKER DIANA	23,6X11,3X4,8			CONSULTAR	
CLINKER HERMES	23,6X11,3X4,8			CONSULTAR	
CLINKER BLANCO	23,6X11,3X4,8			CONSULTAR	

* IVA NO INCLUIDO

oct-22

OFICINA: C/CARACAS, Nº10 (36203) VIGO – TFNOS. 986421617 / 986420560 FAX: 986483297
 ALMACEN VINCOS: RUA OUTEIRO DO FERRO – POLIG. A PASAXE – VINCOS (GONDOMAR) – TFNO: 986467001
 ALMACEN PONTEAREAS: LOMBA, 81 – AREAS (PONTEAREAS) – TFNO: 986640283
 Mail: info@cabadacomercial.com / tecnicos@cabadacomercial.com / ponteareas@cabadacomercial.com
 Web: www.cabadacomercial.com



TARIFA DE PRECIOS



PLAQUETAS

MODELO	UD/M2	MEDIDA	PESO UD	UD CAJA	M2 CAJA	CAJAS/ PALET	PVP CAJA *
MANUAL							
CUERO	72	24X4X1.5	225 gr	64	0.88	72	30,55

- PLAZO DE ENTREGA MÍNIMO 2 SEMANAS

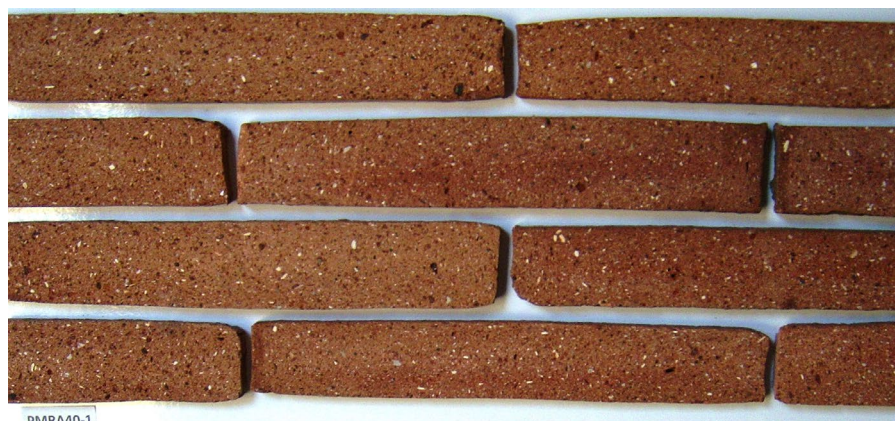

PMRA40-1

* IVA NO INCLUIDO

oct-22

OFICINA: C/CARACAS, Nº10 (36203) VIGO – TFNOS. 986421617 / 986420560 FAX: 986483297
ALMACEN VINCOS: RUA OUTEIRO DO FERRO – POLIG. A PASAXE – VINCOS (GONDOMAR) – TFNO: 986467001
ALMACEN PONTEAREAS: LOMBA, 81 – AREAS (PONTEAREAS) – TFNO: 986640283
Mail: info@cabadacomercial.com / tecnicos@cabadacomercial.com / ponteareas@cabadacomercial.com
Web: www.cabadacomercial.com



TARIFA DE PRECIOS

ARTICULOS				PVP* (€/UD)
Tipos	Medidas	Ud/palet	Ud/m2	
HUECO DOBLE	24X11.5X8	384	33/45	0,176
LADRILLO REFRACTARIO	22X11X5	576		0,981
MEGATOSCO	30X19X12	120	16.6	0,632
TOSCO DE 10 (Rayado)	24X11.5X10	264	36	0,254
PERFORADO (<45%)	24X11.5X7	384	50	0,384
TABIQUERO DE 4.5	33X15X4.5	360	19	0,267
TABIQUERO DE 7	33X15X7	252	19	0,266
	50X20X7	140	9,4	0,555
TABIQUERO DE 8	33X15X8	216	19	0,289
	33x20x8	180	14	0,375
TABIQUERO DE 11	33X15X11	162	19	0,388
	33X20X11	135	14	0,489
TABIQUERO DE 4	40X20X4	240	11.62	0,367
TABLERO METRO 25	100X25X4	96	4	1,329
TABLERO METRO 30	100X30X4	72	3,3	1,609
TABLERO OCHENTA 25	80X25X4	96	5	1,062
ESCALÓN CERÁMICO	16.5X28X32.3	90		2,202
SATEBRICK ACUSTICO 11	40X20X11.5	70	12.5	1,157
SATEBRICK ACUSTICO 14	30X19X14.5	90	16.6	1,105
MEGABRICK TABIQUE	70.5X51.5X7	28	2.75	Consultar
MEGABRICK TABIQUE	70.5X30X11	27	4.73	Consultar

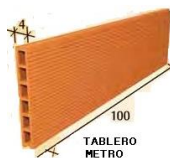

* IVA NO INCLUIDO

feb-24

OFICINA: C/CARACAS, Nº10 (36203) VIGO – TFNOS. 986421617 / 986420560
 ALMACEN VINCOS: RUA OUTEIRO DO FERRO – POLIG. A PASAXE – VINCOS (GONDOMAR) – TFNO: 986467001
 ALMACEN PONTEAREAS: LOMBA, 81 – AREAS (PONTEAREAS) – TFNO: 986640283
 Mail: info@cabadacomercial.com / tecnicos@cabadacomercial.com / ponteareas@cabadacomercial.com
 Web: www.cabadacomercial.com



TARIFA DE PRECIOS



TERMOBRICK®

ARTICULOS					PVP* (€/UD)
Tipo		Medidas axbxc	Ud/palet	Ud/m2	
BASE	14	30X19X14	105	16.6	0,788
	19	30X19X19	75	16.6	1,016
	24	30X19X24	60	16.6	1,281
	29	30X19X29	45	16.6	1,542
MEDIOS (2 UD)	14	15X19X14	90		1,201
	19	15X19X19	75		1,692
	24	15X19X24	60		2,534
	29	15X19X29	45		3,445
REMATES	14	30X10X14 30X14X14	180 105		1,201
	19	30X10X19 30X14X19	150 105		1,692
	24	30X10X24 30X14X24	120 84		2,534
	29	30X10X29 30X14X29	90 63		3,445
TERMINACIÓN	14	30X19X14	105		1,201
	19	30X19X19	75		1,692
	24	30X19X24	60		2,534
	29	30X19X29	45		3,445
ZUNCHOS	14	24X19X14	120		1,201
	19	24X19X19	100		1,692
	24	24X19X24	80		2,534
	29	24X19X29	60		3,445
PIEZA AJUSTE	14	(5/10/5)X19X14	90		1,201
	19	(5/10/5)X19X19	75		1,692
	24	(5/10/5)X19X24	60		2,534
	29	(5/10/5)X19X29	45		3,445
ESQUINAS	14	29X19X14	90		1,201
	19	34X19X19	75		1,692
	24	39X19X24	40		2,534
	29	44X19X29	30		3,445
ARMADURA MURFOR	80		80x3,05x4		9,424
	100		100x3,05x4		9,424
	150		150x3,05x4		9,695
	200		200x3,05x5		10,153

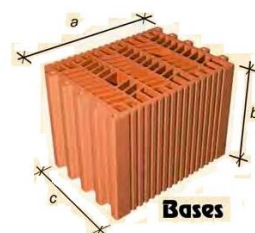

Bases

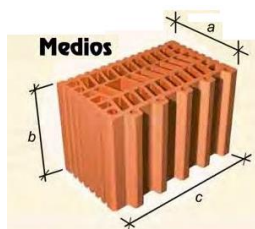

Medios



Terminaciones

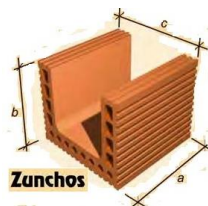

Zunchos

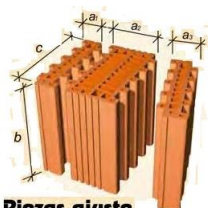

Piezas ajuste

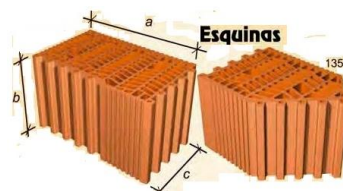

Esquinas

* IVA NO INCLUIDO

feb-24

OFICINA: C/CARACAS, N°10 (36203) VIGO – TFNOS. 986421617 / 986420560
 ALMACEN VINCIOS: RUA OUTEIRO DO FERRO – POLIG. A PASAXE – VINCIOS (GONDOMAR) – TFXO: 986467001
 ALMACEN PONTEAREAS: LOMBA, 81 – AREAS (PONTEAREAS) – TFXO: 986640283
 Mail: info@cabadacomercial.com / tecnicos@cabadacomercial.com / ponteareas@cabadacomercial.com
 Web: www.cabadacomercial.com



TARIFA DE PRECIOS

PLACA FIBROCEMENTO SISTEMA GRAN-ONDA 	COLOR	MEDIDA (cm)	KG/UD	PVP* (€/UD)
		NATURAL	300 X 110	46
250 X 110			38	26,90
200 X 110			31	22,01
152 X 110			23	17,12
RÚSTICO ARCILLA		300 X 110	46	39,47
		250 X 110	38	31,75
		200 X 110	31	27,46
		152 X 110	23	20,59
PLACA PERFIL CURVA 190 (TEJA EURONIT-UM de 16 y 18 cm)	RUSTICO ARCILLA	250 X 98.7	35	39,64
		152 X 98.7	21	23,00
PLACA PERFIL CURVA 230 (TEJA DE BOCA 18 – 22 cm)	TEJA	250 X 96.4	33	36,76
		152 X 96.4	20	22,64
PLACA PERFIL TEJA MIXTA	RÚSTICO ARCILLA	250 X 100	32	35,32
		125 X 100	16	20,45
PLACA ETERBOARD MD de 9mm	NATURAL	250X122	40	88,30

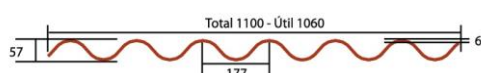
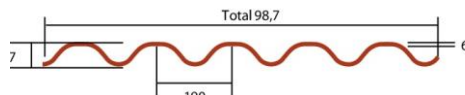
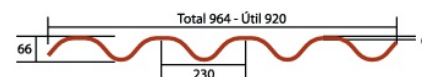
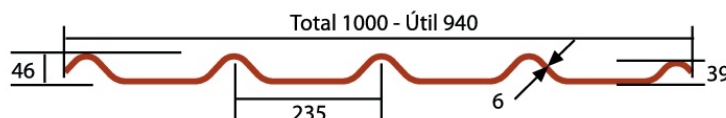
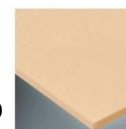
**PLACA GRAN ONDA****PERFIL CURVA 190****PERFIL CURVA 230****PERFIL MIXTA****PLACA ETERBOARD MD**

COMPLEMENTOS DE CUBIERTA		PVP* (€/UD)
CABALLETE ANGULAR 120X30 136°	NATURAL	24,02
	RÚSTICO ARCILLA	24,88
CABALLETE ARTICULADO COMPLETO	NATURAL	27,71
	RÚSTICO ARCILLA	34,32







* IVA NO INCLUIDO

feb-24

OFICINA: C/CARACAS, Nº10 (36203) VIGO – TFNOS. 986421617 / 986420560
 ALMACEN VINCICIOS: RUA OUTEIRO DO FERRO – POLIG. A PASAXE – VINCICIOS (GONDOMAR) – TFNO: 986467001
 ALMACEN PONTEAREAS: LOMBA, 81 – AREAS (PONTEAREAS) – TFNO: 986640283
 Mail: info@cabadacomercial.com / tecnicos@cabadacomercial.com / ponteareas@cabadacomercial.com
 Web: www.cabadacomercial.com



TARIFA DE PRECIOS

ONDULINE BAJO TEJA – color rojo –					
Artículo	Aplicación	Medida			PVP *
		Largo (m)	Ancho (m)	Altura Onda (mm)	€/UD
BT 50	Teja con encaje y pizarra 	2.00	1.00	24	16,40
BT 235	Teja curva entre 18.5-22 cm 	2.00	1.05	38	16,96
BT 200	Teja curva entre 14-18 cm 	2.00	1.05	24	16,04
BT 190	Teja curva + de 22 cm 	2.00	0.95	36	16,17

Nota: Pendientes recomendada entre 10 y 70 % (para pendientes superiores al 50% con las placas BT235 y BT190, se recomienda colocar un listón por debajo de las ondas en las que vaya la fijación).

Colocación de placa Bajo Teja.

- Se colocarán de alero a cumbrera y en sentido contrario a los vientos dominantes.
- En caso de incorporar un elemento aislante, se colocará encima del forjado y debajo de las placas Bajo Teja.
- Se fijarán siempre mecánicamente y por la parte alta de la onda. La fijación debe atravesar las placas Onduline Bajo Teja y el aislamiento (cuando exista) llegando al forjado. El tipo y longitud de la fijación vienen determinados por el tipo de forjado y el espesor del aislamiento. Ver tornillería y accesorios.
- La fijación de las placas BT-150PLUS y BT-200 se realizará en las ondas centrales de forma que no se obstaculice el asentamiento de la teja canal.



- En los solapes, la fijación se realizará a 7cm del borde de la placa.
- No se recomienda la instalación a una temperatura ambiental inferior a 1°C o superior a 40°C.
- En zonas de la cubierta en las que el instalador deba estar más tiempo sobre las placas o por las que deba transitar más, se deberá colocar un tablón para repartir mejor el peso de este entre las ondas de las placas.

Solapes

Pendientes (%)	Nº de Fijaciones por placa	Repercusión x m ²	Distribución
Menor de 40	9	3	3 en el solape inferior, 3 en la parte central y 3 en el solape superior
Mayor de 40	12	3,5	4 en el solape inferior, 4 en la parte central y 4 en el solape superior

Pendientes (%)	Solape mínimo Longitudinal (cm)
Menos de 20	30
Más de 20	15

Placa Bajo Teja	Solape mínimo Lateral (nº de ondas)
BT - 235	1
BT - 150PLUS	2
BT - 200	1
BT - 190	1

* IVA NO INCLUIDO

oct-22

OFICINA: C/CARACAS, Nº10 (36203) VIGO – TFNOS. 986421617 / 986420560 FAX: 986483297
 ALMACEN VINCIOS: RUA OUTEIRO DO FERRO – POLIG. A PASAXE – VINCIOS (GONDOMAR) – TFNO: 986467001
 ALMACEN PONTEAREAS: LOMBA, 81 – AREAS (PONTEAREAS) – TFNO: 986640283

Mail: info@cabadacomercial.com / tecnicos@cabadacomercial.com / ponteareas@cabadacomercial.com

Web: www.cabadacomercial.com



TARIFA DE PRECIOS



ONDUCOBER					
Artículo	Aplicación	Medida			PVP *
		Largo (m)	Ancho (m)	Altura Onda (mm)	€/UD
NEGRO	CUBIERTA, SOBRECUBIERTA Y PARAMENTO 	2.00	0.95	38	14,90
ROJO		2.00	0.95	38	15,85
VERDE		2.00	0.95	38	17,03
GRIS		2.00	0.95	36	18,48
ACCESORIOS					
Artículo	Color	Aplicación	Dimensiones		PVP * (€/UD)
CUMBRERA	Negra	Cubierta y sobrecubierta 	1000x500 mm		8,23
	Roja				8,97
	Verde				12,53
REMATE ONDUCOBER	Rojo, Negro, Verde, Gris	Paramentos A=10CM B= 7 CM	2000x100x70 mm		14,82

* Hasta fin existencias

ONDUVILLA – Teja Asfáltica –			
Artículo	Color	Características	PVP *
SOMBREADO	Rojo y negro	Dimensiones: 40 cm x 106 cm (largo x ancho) Espesor 3 mm Altura Onda: 40 mm // Nº Ondas: 6 Nº Placas por m2: 3.225 Nº Placas por pqte: 7 Superficie útil paquete: 2.17 m2	5,38 €/UD
SOMBREADO	Verde		5,71 €/UD
SOMBREADO	Marrón		5,03 €/UD
ACCESORIOS			
TORNILLO UNIVERSAL DE 6.5		6.5 cm (6 cm útiles) // CAJA 100 UD	11,58 €/Caja
CUMBRERA	SOMBREADO	Largo: 90 cm Ancho: 50 cm 	10,70 €/UD

* IVA NO INCLUIDO

feb-23



TARIFA DE PRECIOS

ACCESORIOS				
Artículo	Aplicación	Dimensiones	Ud/pqte	PVP *
FLASHING BAND	Impermeabilización o sellado de remates de chimenea, alero, etc. Color: ROJO	2.50MX30CM	4	17,90 €/UD
PEINE VENTILACIÓN	Remate de alero anti-pájaros Color negro 	100x8 cm	1	4,47 €/UD
TORNILLO UNIVERSAL	soporte de madera / metal	Longitud:6,5 cm (6 cm útiles)	100	11,58 €/CAJA
CLAVO ESPIRAL	Fijación de BT50,BT150,BT190,BT200 Y BT235 a soporte de madera 	Longitud: 8 cm	200	16,24 €/CAJA
		Longitud: 11.5 cm	200	0,10 €/UD
CLAVO CABEZA PVC	Fijación de BT150,BT190,BT200 Y BT235, y onducober a soporte de madera 	Longitud: 6 cm	400	0,08 €/UD
		Longitud: 7 cm	400	0,08 €/UD
CLAVO TACO	Fijación de BT50, BT150,BT190,BT200 Y BT235, y onducober a soporte de HORMIGÓN 	Longitud: 9 cm	200	23,05 €/CAJA
		Longitud: 13 cm	200	34,41 €/CAJA
ARANDELA	Clavo espiral y clavo taco 	2 x 2 x 0.3 cm	200	0,05 €/UD

* IVA NO INCLUIDO

feb-23

OFICINA: C/CARACAS, Nº10 (36203) VIGO – TFNOS. 986421617 / 986420560
 ALMACEN VINCOS: RUA OUTEIRO DO FERRO – POLIG. A PASAXE – VINCOS (GONDOMAR) – TFNO: 986467001
 ALMACEN PONTEAREAS: LOMBA, 81 – AREAS (PONTEAREAS) – TFNO: 986640283
 Mail: info@cabadacomercial.com / tecnicos@cabadacomercial.com / ponteareas@cabadacomercial.com
 Web: www.cabadacomercial.com



TARIFA DE PRECIOS

ONDUTHERM

TARIMA NATURAL 16mm	YESO 13mm	TABLERO OSB 10mm
H19+A30+TN16	H16+A30+Y13	H19+A30+OSB10
H19+A40+TN16	H16+A40+Y13	H19+A40+OSB10
H19+A50+TN16	H16+A50+Y13	H19+A50+OSB10
H19+A60+TN16	H16+A60+Y13	H19+A60+OSB10
H19+A80+TN16	H16+A80+Y13	H19+A80+OSB10
H19+A100+TN16	H16+A100+Y13	H19+A100+OSB10



Barnizado Nogal 10mm	Natural 10mm	Barnizado 10 mm
H16+A30+FABN10	H16+A30+FAN10	H19+A30+FAB10
H16+A40+FABN10	H16+A40+FAN10	H19+A40+FAB10
H16+A50+FABN10	H16+A50+FAN10	H19+A50+FAB10
H16+A60+FABN10	H16+A60+FAN10	H19+A60+FAB10
H16+A80+FABN10	H16+A80+FAN10	H19+A80+FAB10
H16+A100+FABN10	H16+A100+FAN10	H19+A100+FAB10

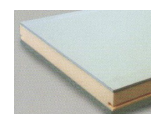

TABLERO CEMENTO MADERA 10mm	TABLERO AGLOMERADO HIDRÓFUGO 10mm
H16+A30+CM10	H19+A30+H10
H16+A40+CM10	H19+A40+H10
H16+A50+CM10	H19+A50+H10
H16+A60+CM10	H19+A60+H10
H16+A80+CM10	H19+A80+H10
H16+A100+CM10	H19+A100+H10



Friso abeto natural 13mm	Tablero aglomerado hidrófugo 16mm
A30+FAN13	A30+H16
A40+FAN13	A40+H16
A50+FAN13	A50+H16
A60+FAN13	A60+H16
A80+FAN13	A80+H16
A100+FAN13	A100+H16

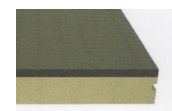
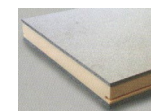

PRECIOS A CONSULTAR.

Producto bajo pedido. Consultar plazos de entrega.

oct-22



TARIFA DE PRECIOS

Onduclair: Productos Plásticos

ROLLO POLIÉSTER		PVP*																									
		€/M2	€/UD																								
 <p>ROLLO PLR LISO</p> <table border="1"> <tr> <td>Ancho</td> <td>Largo (m)</td> <td>Espesor</td> </tr> <tr> <td>1,25 m</td> <td>30</td> <td>1 mm</td> </tr> <tr> <td>Peso (kg/m²)</td> <td colspan="2">Transmisión Luminosa</td> </tr> <tr> <td>1,33</td> <td colspan="2">83 %</td> </tr> </table> <p>ROLLO PLR ONDULADO</p> <table border="1"> <tr> <td>Ancho</td> <td>Largo (m)</td> <td>Espesor</td> </tr> <tr> <td>1,25 m</td> <td>30</td> <td>0,7 mm</td> </tr> <tr> <td>Peso (kg/m²)</td> <td colspan="2">Transmisión Luminosa</td> </tr> <tr> <td>1,04</td> <td colspan="2">83 %</td> </tr> </table>	Ancho	Largo (m)	Espesor	1,25 m	30	1 mm	Peso (kg/m ²)	Transmisión Luminosa		1,33	83 %		Ancho	Largo (m)	Espesor	1,25 m	30	0,7 mm	Peso (kg/m ²)	Transmisión Luminosa		1,04	83 %		LISO	9,26	347,17
	Ancho	Largo (m)	Espesor																								
1,25 m	30	1 mm																									
Peso (kg/m ²)	Transmisión Luminosa																										
1,33	83 %																										
Ancho	Largo (m)	Espesor																									
1,25 m	30	0,7 mm																									
Peso (kg/m ²)	Transmisión Luminosa																										
1,04	83 %																										
	ONDULADO	6,79	254,50																								

PLACA POLIÉSTER		Largo m	PVP*																									
			€/M2	€/UD																								
 <p>MINI ONDA PLR</p> <table border="1"> <tr> <td>Ancho</td> <td>Largo (m)</td> <td>Espesor</td> </tr> <tr> <td>1,12 m</td> <td>1,5 - 2 - 2,5 - 3</td> <td>1 mm</td> </tr> <tr> <td>Peso (kg/m²)</td> <td colspan="2">Transmisión Luminosa</td> </tr> <tr> <td>1,58</td> <td colspan="2">85 %</td> </tr> </table> <p>GRAN ONDA PLR</p> <table border="1"> <tr> <td>Ancho</td> <td>Largo (m)</td> <td>Espesor</td> </tr> <tr> <td>1,1 m</td> <td>1,5 - 2 - 2,5 - 3</td> <td>1 mm</td> </tr> <tr> <td>Peso (kg/m²)</td> <td colspan="2">Transmisión Luminosa</td> </tr> <tr> <td>1,68</td> <td colspan="2">85 %</td> </tr> </table>	Ancho	Largo (m)	Espesor	1,12 m	1,5 - 2 - 2,5 - 3	1 mm	Peso (kg/m ²)	Transmisión Luminosa		1,58	85 %		Ancho	Largo (m)	Espesor	1,1 m	1,5 - 2 - 2,5 - 3	1 mm	Peso (kg/m ²)	Transmisión Luminosa		1,68	85 %		MINI ONDA	1,52	9,59	16,33
	Ancho	Largo (m)	Espesor																									
	1,12 m	1,5 - 2 - 2,5 - 3	1 mm																									
	Peso (kg/m ²)	Transmisión Luminosa																										
	1,58	85 %																										
	Ancho	Largo (m)	Espesor																									
	1,1 m	1,5 - 2 - 2,5 - 3	1 mm																									
	Peso (kg/m ²)	Transmisión Luminosa																										
1,68	85 %																											
2,00	21,49																											
2,50	26,86																											
3,00	32,23																											
GRAN ONDA	1,52	9,59	16,04																									
	2,00		21,10																									
	2,50		26,38																									
	3,00		31,66																									

PLACA POLICARBONATO		Largo m	PVP*																									
			€/M2	€/UD																								
 <p>MINI ONDA PC</p> <table border="1"> <tr> <td>Ancho</td> <td>Largo (m)</td> <td>Espesor</td> </tr> <tr> <td>1,12 m</td> <td>1,5 - 2 - 2,5 - 3</td> <td>0,8 mm</td> </tr> <tr> <td>Peso (kg/m²)</td> <td colspan="2">Transmisión Luminosa</td> </tr> <tr> <td>1,06</td> <td colspan="2">90 %</td> </tr> </table> <p>GRAN ONDA PC</p> <table border="1"> <tr> <td>Ancho</td> <td>Largo (m)</td> <td>Espesor</td> </tr> <tr> <td>1,1 m</td> <td>1,5 - 2 - 2,5 - 3</td> <td>1 mm</td> </tr> <tr> <td>Peso (kg/m²)</td> <td colspan="2">Transmisión Luminosa</td> </tr> <tr> <td>1,44</td> <td colspan="2">90 %</td> </tr> </table>	Ancho	Largo (m)	Espesor	1,12 m	1,5 - 2 - 2,5 - 3	0,8 mm	Peso (kg/m ²)	Transmisión Luminosa		1,06	90 %		Ancho	Largo (m)	Espesor	1,1 m	1,5 - 2 - 2,5 - 3	1 mm	Peso (kg/m ²)	Transmisión Luminosa		1,44	90 %		MINI ONDA	1,52	14,80	25,20
	Ancho	Largo (m)	Espesor																									
	1,12 m	1,5 - 2 - 2,5 - 3	0,8 mm																									
	Peso (kg/m ²)	Transmisión Luminosa																										
	1,06	90 %																										
	Ancho	Largo (m)	Espesor																									
	1,1 m	1,5 - 2 - 2,5 - 3	1 mm																									
	Peso (kg/m ²)	Transmisión Luminosa																										
1,44	90 %																											
2,00	33,15																											
2,50	41,44																											
3,00	49,73																											
GRAN ONDA	1,52	14,80	24,75																									
	2,00		32,56																									
	2,50		40,70																									
	3,00		48,84																									

* IVA NO INCLUIDO

oct-22

OFICINA: C/CARACAS, Nº10 (36203) VIGO – TFNOS. 986421617 / 986420560 FAX: 986483297
 ALMACEN VINCIOS: RUA OUTEIRO DO FERRO – POLIG. A PASAXE – VINCIOS (GONDOMAR) – TFNO: 986467001
 ALMACEN PONTEAREAS: LOMBA, 81 – AREAS (PONTEAREAS) – TFNO: 986640283
 Mail: info@cabadacomercial.com / tecnicos@cabadacomercial.com / ponteareas@cabadacomercial.com
 Web: www.cabadacomercial.com



TARIFA DE PRECIOS

Onduclair: Productos Plásticos

PLACA PC CELULAR	ESPESOR mm	Nº PAREDES	LARGO m	PVP*	
				€/M2	€/UD
	4	2	2,00	9,73	19,07
	6	2	2,00	14,94	29,28
	10	2	2,00	18,60	36,46
			3,00		54,69
	16	5	2,00	30,20	59,20
			3,00		88,80
		Diamante	2,00	23,25	45,57
			3,00		68,36

PRODUCTO	PERFIL	ESPESOR (mm)	Nº DE PAREDES	PESO (kg/m ²)	ANCHO (m)	LARGO (m)
PC CELULAR 4		4	2	0,80	0,98	2
PC CELULAR 6		6	2	1,30	0,98	2
PC CELULAR 10		10	2	1,50	0,98	2-3
PC CELULAR 16		16	5	1,90	0,98	2-3
PC CELULAR 16		16	Diamante	2,50	0,98	2-3

Accesorios Policarbonato	ESPESOR mm	LARGO m	PVP* €/UD
PERFIL H	4,00	2,00	10,85
	6,00	2,00	10,85
	10,00	2,00	12,08
		3,00	18,13
	16,00	2,00	16,44
		3,00	24,66
PERFIL U	4,00	2,10	3,28
	6,00	2,10	3,28
	10,00	2,10	4,40
	16,00	2,10	6,90

ACCESORIOS	Perfil	LARGO (L x A)
PERFIL H PERFIL U		2 m (PC 4-6mm) / 2-3 (PC 10-16 mm) 2,1 m

* IVA NO INCLUIDO

oct-22

OFICINA: C/CARACAS, Nº10 (36203) VIGO – TFNOS. 986421617 / 986420560 FAX: 986483297
 ALMACEN VINCIOS: RUA OUTEIRO DO FERRO – POLIG. A PASAXE – VINCIOS (GONDOMAR) – TFNO: 986467001
 ALMACEN PONTEAREAS: LOMBA, 81 – AREAS (PONTEAREAS) – TFNO: 986640283
 Mail: info@cabadacomercial.com / tecnicos@cabadacomercial.com / ponteareas@cabadacomercial.com
 Web: www.cabadacomercial.com



TARIFA DE PRECIOS

Artículo	Descripción	A	B	C	Espesor	PVP* (€/UD)
(004010) OMEGA DE 15X15X29X0,6 DE 5 ML	Perfil acero galvanizado Construcción de estructura para teja.	15	15	29	0,6	7,20
(004025) OMEGA DE 17X30X20X0,6 DE 5 ML		17	30	20	0,6	9.00

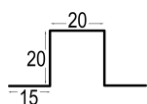
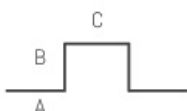
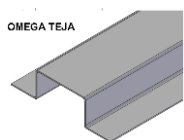

ARTICULOS		PVP* (€/UD)
(LM) LISTON METÁLICO 15x20x20x0.6mm DE 2m	Perfil acero galvanizado lacado blanco . Apoyo para teja mixta, plana o de hormigón.	2,95

ARTICULO		PVP* (€/UD)	
(GTI) GANCHO TEJA INOX	72 x12 x 20 x2.4	0,05	
ARTICULOS		PVP* (€/UD)	
VARILLA RECTA M7	Ø6 350MM	Fabricada en acero Anclaje para chapas metálicas y de fibrocemento	0,32
	Ø6 400MM		0,34
GANCHO FIBROCEMENTO DE 6	230X115X20	Fabricado en alambre de acero Sujeción de cubiertas metálicas o de fibrocemento a viguetas metálicas o de hormigón	0,26
	260X115X20		0,27
ARTICULOS		PVP* (€/UD)	
TORNILLO ROSCA SALOMÓNICA Ø 6 longitud:110 mm	Fabricada en alambre de acero Sujeción de cubiertas metálicas y de fibrocemento a madera	0,18	



ARTICULOS		PVP* (€/UD)
CHAPA TRASLUZ GRAN-ONDA Equipada	Fabricada en chapa galvanizada Ø 6 MM	0,09
CHAPA MINI-ONDA Equipada		0,11
APOYAONDAS GRAN-ONDA altura 50mm	Fabricada en polipropileno Apoyo de chapas traslúcidas gran-onda	0,16
APOYAONDAS MINI-ONDA altura 18 mm	Fabricada en polipropileno Apoyo de chapas mini-onda	0,11

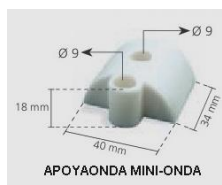

ARTICULO	PVP* (€/UD)
CAPERUZA PLÁSTICA PARA TORNILLO	0,08

* IVA NO INCLUIDO

ene-24

OFICINA: C/CARACAS, Nº10 (36203) VIGO – TFNOS. 986421617 / 986420560
 ALMACEN VINCOS: RUA OUTEIRO DO FERRO – POLIG. A PASAXE – VINCOS (GONDOMAR) – TFNO: 986467001
 ALMACEN PONTEAREAS: LOMBA, 81 – AREAS (PONTEAREAS) – TFNO: 986640283
 Mail: info@cabadacomercial.com / tecnicos@cabadacomercial.com / ponteareas@cabadacomercial.com
 Web: www.cabadacomercial.com



TARIFA DE PRECIOS



CÓDIGO	ARTÍCULO	PVP (€/M)	PVP (€/UD)
020110160	Lámina transpirable impermeable USB CLASSIC 185 gr/m2 1.50mx50m-75m2 (CUBIERTAS) *Hasta final de stock	1,73 M ²	129.62
02010191	Membrana impermeable traspirable DO135 143gr/m2 1.50mx50m-75m2 (CUBIERTAS) *Hasta final de stock	0,99 M ²	74,00
02010090	Membrana impermeable transpirable USB WALL 120 120 gr/m2 1.50mx50m-75m2 (FACHADAS) *Hasta final de stock	1,25 M ²	93,50
02040160	Cinta adhesiva USB TAPE 1 PE 60mmx25m – Cinta adhesiva flexible de polietileno. Adhesión inicial: MUY ALTA	0,73 ML	18.25
02040162	Cinta adhesiva USB TAPE RAPID 60mmx50m – Cinta acrílica de una cara, ausencia de liner.	0,59 ML	29.50
020401616	Cinta adhesiva TAPE GREEN 60mmx25m – Cinta adhesiva flexible de polietileno. Adhesión inicial: ALTA.	0,43 ML	10.75
02040250	Cinta adhesiva de doble cara TAPE 2 AC 50mmx50m	0,43 ML	21.50
02064007	Pantalla barrera total vapor DS 1500 SYN 130g/m2 50mx1.5m – ANTI RADÓN	3,70 M ²	277.40



CÓDIGO	ARTÍCULO	PVP
ABV90	Barrera de vapor AISREC DE 1.50mx50m (75m2) - 90 gr (2 capas)	72,00
AIT130	AISREC – Lámina transpirable impermeable 130 gr - 75m2	64,40
AIBT29815X20	AISREC – Impermeable de baños 1,5 x 20 m	154,50
KIDA1	Kit impermeabilización y desagüe AISREC MOD 1	22,65
CA1C5025	CINTA ADHESIVA 1 CARA 50mmx25m Para unión y reparaciones de lám. Imperm -transp.	11,90
05RUL001	RODILLO DE PLÁSTICO RÍGIDO	1,92



* IVA NO INCLUIDO

ene-24



TARIFA DE PRECIOS

ARTICULOS			PVP* (€/UD)	
T881	TORNILLO PREMONTADO (con taco) Ø 4.8mm	8x80	Colocación rastrel	0,11
TB810		8x100	* Los de 120 y 140 se recomiendan para colocación de chapa fibrocemento en placas de hormigón.	0,13
T8120		8x120		0,16
TB814		8x140		0,18



ARTICULO			PVP* (€/UD)
CC25RT	CLIP CUMBRERA 25 R MIXTA	Fabricado en aluminio prelacado rojo teja Apto para teja curva de 15 a 25 mm espesor	0,31
SC50	SOPORTE CABALLETE RASTREL 50 MM	Fabricado en chapa acero galvanizada	1,18
LA500X2R	LIMAHOYA ALU 500MMX2M ROJA	Impermeab. de canales longitudinales	22,00
1651AR	PEINE ANTIPAJAROS 100X2,5+5,5	Cierrateja con listelo perforado para techos ventilados	1,30
TER131652P	PEINE UNIVERSAL PLASTICO ROJO	Elemento adaptable al perfil de tejas	1,25
1651LR	RASTREL PERFORADO ROJO 100X2.5	Para cubiertas ventiladas	1,05
RVA400	ROLL-VENT ALU 400mm x 5m	Remate para cumbreras y limatesas ventiladas	21,31



Peine Universal plástico rojo



LIMAHOYA ALU - ROJA -



CLIP CUMBRERA 25 ROJO TEJA



SOPORTE CABALLETE PARA RASTREL



ROLL-VENT ALU



aplicación con pistola



aplicación con cánula

ACCESORIOS PARA TEJA

ARTICULO	PVP* (€/UD)
ESPUMA PISTOLA DE 750 ML	7,59
ESPUMA CANULA 750 ML	8,12
LIMPIADOR ESPUMA BOTE 500 ML	9,20
PISTOLA PARA ESPUMA	54,34
CONJUNTO PLETINA + TORNILLO	3,22
TORNILLO PLETINA 3.5X35	0,03
PERFIL CUMBRERA 3000X30X1.3	10,75
UNION PERFIL	0,31
GRAPA SUJECCION CUMBRERA	0,56
TORNILLO 48X30 CUMBRERA	0,07

* IVA NO INCLUIDO

jul-23

OFICINA: C/CARACAS, Nº10 (36203) VIGO – TFNOS. 986421617 / 986420560
 ALMACEN VINCICIOS: RUA OUTEIRO DO FERRO – POLIG. A PASAXE – VINCICIOS (GONDOMAR) – TFNO: 986467001
 ALMACEN PONTEAREAS: LOMBA, 81 – AREAS (PONTEAREAS) – TFNO: 986640283
 Mail: info@cabadacomercial.com / tecnicos@cabadacomercial.com / ponteareas@cabadacomercial.com
 Web: www.cabadacomercial.com



TARIFA DE PRECIOS

ARTÍCULO	PVP *	
PANEL SIMPLE DE 3 o 5 GRECAS – MODELO C1 – PERFIL 40 MM (cortado a medida en múltiplos de 0.50) Espesor de chapa 0.5mm	17,90 €/M2	
PANEL CON AISLAMIENTO DE 3 o 5 GRECAS – MODELO C1 (aislante de poliuretano de 30 mm y acabado en chapa prelacada blanca)	3 GRECAS	28,00 €/M2
	5 GRECAS	24,00 €/M2
PANEL TEJA CON AISLAMIENTO DE 40 MM y acabado en chapa prelacada roja/blanca (Cortada a medida en múltiplos de 0.35)	41,40 €/M2	
REMATE FRONTAL PANEL TEJA 1 ML	12,10 €/UD	
CUMBRERA DOBLE EN DOS MITADES DE 1 ML	54,95 €/UD	
REMATE TRASERO TROQUELADO 1 ML	20,00 €/UD	
REMATE LATERAL PANEL TEJA DE 3 ML DE 40MM ESPESOR	24,40 €/UD	

Precios orientativos debido a las variaciones en el mercado

CHAPA PERFILADA MODELO SERIE C1

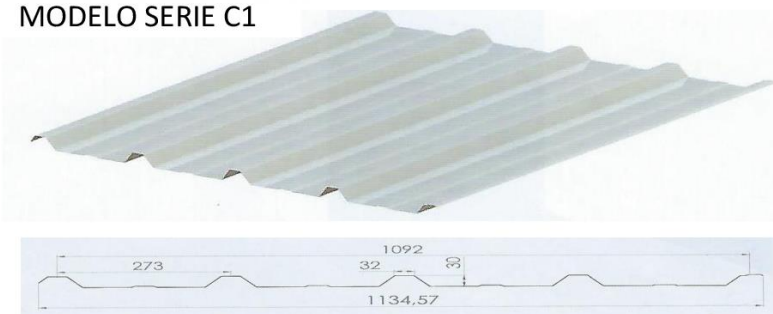

PANEL TIPO TEJA MODELO SERIE C1

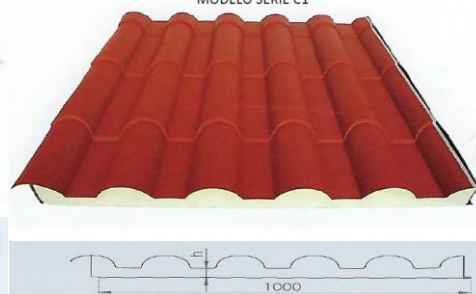

PANEL DE CUBIERTA MODELO SERIE C1-5-1000

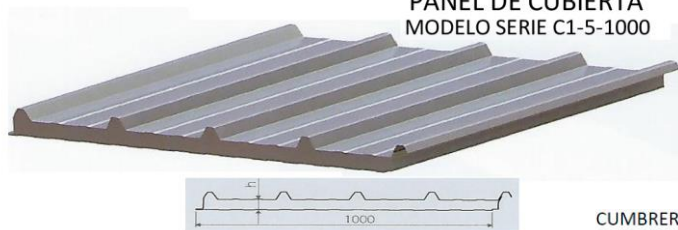

REMATE FRONTAL



CUMBRERA DOBLE EN 2 MITADES



REMATE LATERAL D-250

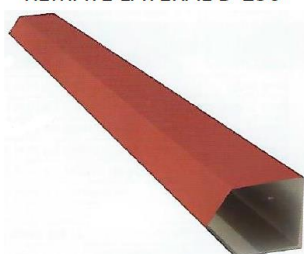

REMATES TRASEROS TROQUELADOS D-416

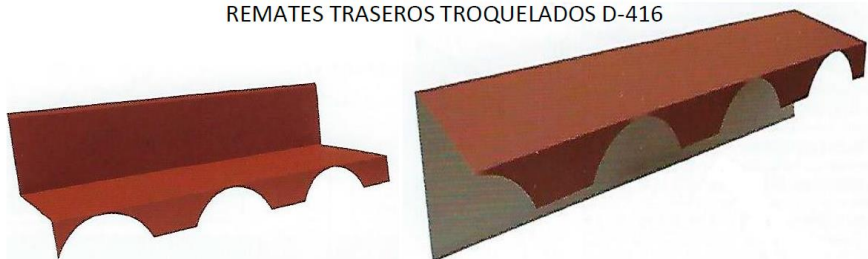

* IVA NO INCLUIDO

dic-23

OFICINA: C/CARACAS, Nº10 (36203) VIGO – TFNOS. 986421617 / 986420560 FAX: 986483297
 ALMACEN VINCOS: RUA OUTEIRO DO FERRO – POLIG. A PASAXE – VINCOS (GONDOMAR) – TFNO: 986467001
 ALMACEN PONTEAREAS: LOMBA, 81 – AREAS (PONTEAREAS) – TFNO: 986640283
 Mail: info@cabadacomercial.com / tecnicos@cabadacomercial.com / ponteareas@cabadacomercial.com
 Web: www.cabadacomercial.com



TARIFA DE PRECIOS

SANITARIO						
ARTICULO	CM	Uds/m2	Uds/palet	M2/palet	PVP (€/m2)	PVP (€/ud)
COFRATTO						
H 5	50 X 50	4	400	100	9.30	2.32
H10	50 X 50	4	200	50	11.73	2.93
FERRACIN						
H15	58 X 58	3	340	113.33	12.83	4.28
H20	58 X 58	3	340	113.33	13.21	4.40
H25	58 X 58	3	340	113.33	13.66	4.55
H30	56 X 56	3.2	260	81.25	15.87	4.96
H35	56 X 56	3.2	260	81.25	16.04	5.01
H40	56 X 56	3.2	220	68.75	18.49	5.78
H45	56 X 56	3.2	220	68.75	18.88	5.90
H50	56 X 56	3.2	220	68.75	19.62	6.13
H60	71 X 71	2	60	30.00	28.56	14.28
H65	71 X 71	2	60	30.00	29.10	14.55



ENTRA EN VIGOR 15 DE MARZO DE 2023

* IVA NO INCLUIDO

mar-23

OFICINA: C/CARACAS, Nº10 (36203) VIGO – TFNOS. 986421617 / 986420560
 ALMACEN VINCOS: RUA OUTEIRO DO FERRO – POLIG. A PASAXE – VINCOS (GONDOMAR) – TFNO: 986467001
 ALMACEN PONTEAREAS: LOMBA, 81 – AREAS (PONTEAREAS) – TFNO: 986640283
 Mail: info@cabadacomercial.com / tecnicos@cabadacomercial.com / ponteareas@cabadacomercial.com
 Web: www.cabadacomercial.com



TARIFA DE PRECIOS

TUBOS PARA ENCOFRADO

PILAR CIRCULAR LISO		
DIÁMETRO	LONGITUD	PVP (€/ML)
200 *	3 ML	11,77
250	3 ML	15,72
250	4 ML	15,72
300	3 ML	19,05
300	4 ML	19,05
350 *	3 ML	21,08
400 *	3 ML	26,43



* hasta fin existencias.

MAILLA ELECTROSOLDADA

ARTICULOS	PVP* (€/UD)
MALLAZO 30X20X5	15,76
MALLAZO 15X15X5	25,73
MALLAZO 15X15X6	37,08
MALLAZO 15X15X8	63,51
MALLAZO 15X15X10	100,66
MALLAZO 15X15X12	135,55
MALLAZO 20X20X5	20,26
MALLAZO 20X20X6	27,81
MALLAZO 20X20X8	47,00
MALLAZO 20X20X10	74,53
MALLAZO 20X20X12	103,07

**MEDIDA:
6X2.20
13.20 M2**

**PRECIOS
ORIENTATIVOS
- CONSULTAR
-**



Fibra PP

ARTICULOS	PVP* (€/UD)
FIBRA PP 12 MM BOLSA DE 600 GR	3.09

* Fibra para hormigón. Fabricada en polipropileno.
Se utiliza para que la parte superior del hormigón no se agriete.



* IVA NO INCLUIDO

1 de Noviembre de 2023

OFICINA: C/CARACAS, Nº10 (36203) VIGO – TFNOS. 986421617 / 986420560
 ALMACEN VINCIOS: RUA OUTEIRO DO FERRO – POLIG. A PASAXE – VINCIOS (GONDOMAR) – TFNO: 986467001
 ALMACEN PONTEAREAS: LOMBA, 81 – AREAS (PONTEAREAS) – TFNO: 986640283
 Mail: info@cabadacomercial.com / tecnicos@cabadacomercial.com / ponteareas@cabadacomercial.com
 Web: www.cabadacomercial.com



TARIFA DE PRECIOS VIGUETA ARMADA

ARTICULOS		PVP* (€/ML)	ARTICULOS		PVP* (€/ML)
CUBIERTA			VIVIENDA		
12	V1 HASTA 2,70 ML	CONSULTAR	17	V1 HASTA 2,50 ML	CONSULTAR
	V2 HASTA 3,30 ML			V2 HASTA 3,10 ML	
	V3 HASTA 3,80 ML			V3 HASTA 3,40 ML	
	V4 HASTA 3,90 ML			V4 HASTA 3,50 ML	
	V5 HASTA 4,20 ML			V5 HASTA 3,90 ML	
	V6 HASTA 4,50 ML			V6 HASTA 4,20 ML	
	V7 HASTA 4,70 ML			V7 HASTA 4,30 ML	
	V8 HASTA 4,90 ML			V8 HASTA 4,50 ML	
	V9 HASTA 5,30 ML			V9 HASTA 4,90 ML	
	V10 HASTA 5,40 ML			V13 HASTA 5,50 ML	
	V11 HASTA 5,50 ML				
17	V1 HASTA 3,10 ML	CONSULTAR	20	V1 HASTA 3,00 ML	CONSULTAR
	V2 HASTA 3,80 ML			V2 HASTA 3,20 ML	
	V3 HASTA 4,30 ML			V3 HASTA 3,70 ML	
	V4 HASTA 4,40 ML			V5 HASTA 4,10 ML	
	V5 HASTA 4,80 ML			V6 HASTA 4,40 ML	
	V6 HASTA 5,20 ML			V7 HASTA 4,60 ML	
	V7 HASTA 5,40 ML			V8 HASTA 4,80 ML	
	V8 HASTA 5,60 ML			V9 HASTA 5,20 ML	
	V9 HASTA 6,00 ML			V11 HASTA 5,60 ML	
	V10 HASTA 6,10 ML			V13 HASTA 5,90 ML	
	V11 HASTA 6,30 ML			V14 HASTA 6,00 ML	
20	V1 HASTA 4,00 ML	CONSULTAR	25	V1 HASTA 3,00 ML	CONSULTAR
	V2 HASTA 4,10 ML			V2 HASTA 3,50 ML	
	V3 HASTA 4,60 ML			V3 HASTA 3,90 ML	
	V4 HASTA 4,70 ML			V4 HASTA 4,00 ML	
	V5 HASTA 5,20 ML			V5 HASTA 4,40 ML	
	V6 HASTA 5,50 ML			V6 HASTA 4,70 ML	
	V7 HASTA 5,80 ML			V7 HASTA 4,90 ML	
	V8 HASTA 6,00 ML			V8 HASTA 5,20 ML	
	V9 HASTA 6,50 ML			V9 HASTA 5,50 ML	
	V11 HASTA 6,90 ML			V10 HASTA 5,60 ML	
	25			V1 HASTA 4,70 ML	
V3 HASTA 4,80 ML		V12 HASTA 6,05 ML			
V4 HASTA 4,90 ML		V13 HASTA 6,30 ML			
V5 HASTA 5,40 ML		V14 HASTA 6,60 ML			
V6 HASTA 5,80 ML		V15 HASTA 6,90 ML			
V7 HASTA 6,00 ML		V16 HASTA 7,30 ML			
V8 HASTA 6,30 ML		V18 HASTA 7,80 ML			
V9 HASTA 6,80 ML		V19 HASTA 7,90 ML			
V10 HASTA 6,90 ML					
V11 HASTA 7,30 ML					
V13 HASTA 7,80 ML					
V14 HASTA 7,90 ML					

- SP.: SUELA DE POLIESTIRENO DE 3 CM AUMENTA.....0,55 €/ML
- D.C.: DOBLE CELOSÍA POR CORTANTE.....0,55 €/ML

* IVA NO INCLUIDO

oct-22

OFICINA: C/CARACAS, Nº10 (36203) VIGO – TFNOS. 986421617 / 986420560 FAX: 986483297
 ALMACEN VINCIOS: RUA OUTEIRO DO FERRO – POLIG. A PASAXE – VINCIOS (GONDOMAR) – TFNO: 986467001
 ALMACEN PONTEAREAS: LOMBA, 81 – AREAS (PONTEAREAS) – TFNO: 986640283
 Mail: info@cabadacomercial.com / tecnicos@cabadacomercial.com / ponteareas@cabadacomercial.com
 Web: www.cabadacomercial.com



TARIFA DE PRECIOS

VIGUETA ARMADA

ARTICULOS		PVP* (€/ML)
VIVIENDA		
30	V1 HASTA 3,00 ML	CONSULTAR
	V2 HASTA 3,50 ML	
	V3 HASTA 3,90 ML	
	V4 HASTA 4,00 ML	
	V5 HASTA 4,40 ML	
	V6 HASTA 4,70 ML	
	V7 HASTA 4,90 ML	
	V8 HASTA 5,20 ML	
	V9 HASTA 5,50 ML	
	V10 HASTA 5,60 ML	
	V11 HASTA 6,00 ML	
	V12 HASTA 6,05 ML	
	V13 HASTA 6,30 ML	
	V14 HASTA 6,60 ML	
	V15 HASTA 6,90 ML	
	V16 HASTA 7,30 ML	
	V17 HASTA 7,60 ML	
	V18 HASTA 7,90 ML	
	V19 HASTA 8,00 ML	

- S.P.: SUELA DE POLIESTIRENO DE 3 CM AUMENTA..... 0,55 €/ML
- D.C.: DOBLE CELOSIA POR CORTANTE..... 0,55 €/ML

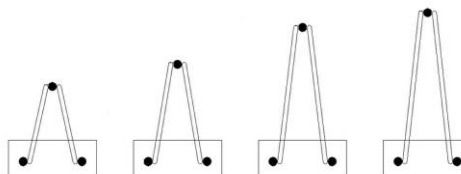
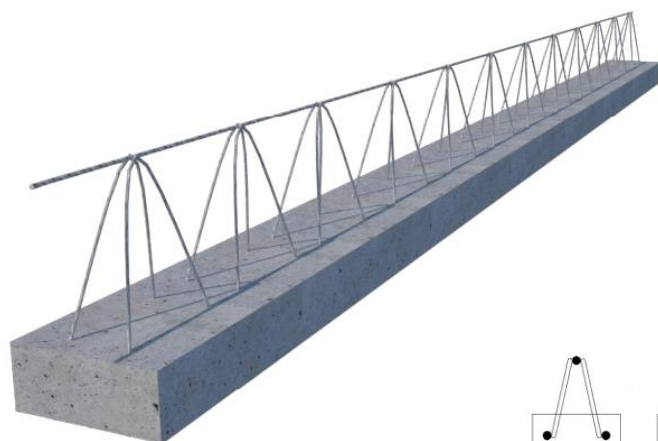

* IVA NO INCLUIDO

oct-22

OFICINA: C/CARACAS, Nº10 (36203) VIGO – TFNOS. 986421617 / 986420560 FAX: 986483297
 ALMACEN VINCOS: RUA OUTEIRO DO FERRO – POLIG. A PASAXE – VINCOS (GONDOMAR) – TFNO: 986467001
 ALMACEN PONTEAREAS: LOMBA, 81 – AREAS (PONTEAREAS) – TFNO: 986640283
 Mail: info@cabadacomercial.com / tecnicos@cabadacomercial.com / ponteareas@cabadacomercial.com
 Web: www.cabadacomercial.com



TARIFA DE PRECIOS

BOVEDILLA DE HORMIGÓN

CANTO	Dimensiones mm	Kg/ud	Ud/palet	PVP* (€/UD)
70/12	625x250x110	15	60	0,92
70/17	625x250x165	19	44	1,00
70/20 ABIERTA	625x250x200	21.5	40	1,09
70/20 CERRADA	625x250x200	21.5	40	1,14
70/25 ABIERTA	625x220x250	21	36	1,21
70/25 CERRADA	625x220x250	21	36	1,31
70/30	625x200x300	21.2	30	1,39



BOVEDILLA DE ARLITA

CANTO	Dimensiones mm	Kg/ud	Ud/palet	PVP* (€/UD)
70/12	625x250x110	9	60	1,47
70/17	625x250x165	11	44	1,77
70/20 ABIERTA	625x250x200	12.5	40	1,95
70/20 CERRADA	625x250x200	12.5	40	2,03
70/25 ABIERTA	625x220x250	12	36	2,06
70/25 CERRADA	625x220x250	12	36	2,12
PALET DE MADERA				14,00



BOVEDILLA DE POLIESTIRENO

TIPO	Densidad kg/m3	Dimensiones mm	CANTO	PVP* (€/UD)
P - I	9 - 10	125 X 625	20	8,27
		125 X 625	25	10,33
		100 X 625	30	9,92
P - III	13.5 - 15	100 X 625	15	6,97
		125 X 625	17	9,88
		125 X 625	20	11,62
		125 X 625	25	14,52
		100 X 625	30	13,94
P - IV	18 - 20	125 X 625	12	8,98
		100 X 625	15	8,98
		125 X 625	17	12,72
		125 X 625	20	14,97
		125 X 625	25	18,71

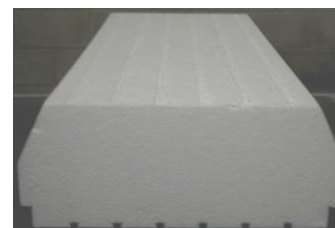

BOVEDILLA CERÁMICA

ARTÍCULO	UDS/ PALET	KG/UD	PVP (€/UD)
BOVEDILLA 70 X 25 X 14	70	10	CONSULTAR
BOVEDILLA 70 X 25 X 17	60	11	CONSULTAR
BOVEDILLA 70 X 25 X 20	50	11,80	CONSULTAR
BOVEDILLA 70 X 25 X 25	40	14,30	CONSULTAR
BOVEDILLA 70 X 25 X 30	30	15,50	CONSULTAR
Tapa bovedilla poliestireno P3 de 20			CONSULTAR
Tapa bovedilla poliestireno P3 de 25			CONSULTAR
BOVEDILLA CERAMICA CURVA 13	620x240x127	Ud/m2:5,6	CONSULTAR

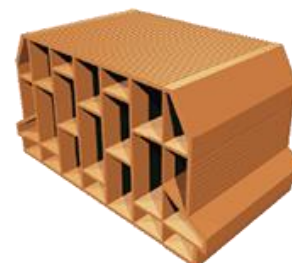

* IVA NO INCLUIDO

dic-23

OFICINA: C/CARACAS, Nº10 (36203) VIGO – TFNOS. 986421617 / 986420560
 ALMACEN VINCOS: RUA OUTEIRO DO FERRO – POLIG. A PASAXE – VINCOS (GONDOMAR) – TFNO: 986467001
 ALMACEN PONTEAREAS: LOMBA, 81 – AREAS (PONTEAREAS) – TFNO: 986640283
 Mail: info@cabadacomercial.com / tecnicos@cabadacomercial.com / ponteareas@cabadacomercial.com
 Web: www.cabadacomercial.com



TARIFA DE PRECIOS

ARTICULOS	PVP* (€/UD)
SEPARADOR CONDOR	0,09
SEPARADOR TIMON	0,06
SEPARADOR HORMIGON	0,11
SEPARADOR UNIFOR PFI01 – HORMIGÓN	0,15
SEPARADOR UNIFOR PFI02 – POLIESTIRENO	0,18
SETA PROTECTORA ARMADURA	0,11



Condor



Timón

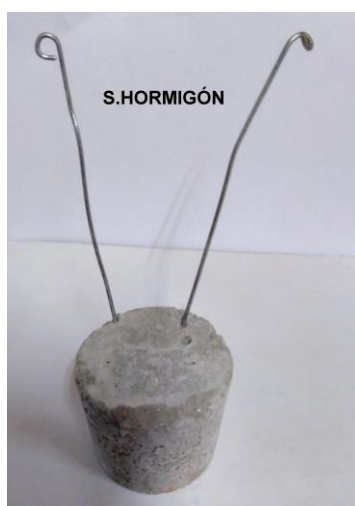

SEPARADOR UNIFOR PFI02 - POLIESTIRENO



REF.	MEDIDA mm				
	L	x	A	x	D
PFI02	85	x	60	x	17

- Corrugado de hasta 16 mm y placas poliestireno.

SEPARADOR UNIFOR - PFI01 - Hormigón



REF.	MEDIDA mm				
	L	x	A	x	D
PFI01	85	x	30	x	17

- Corrugado de hasta 16 mm.

* IVA NO INCLUIDO

ene-24

OFICINA: C/CARACAS, Nº10 (36203) VIGO – TFNOS. 986421617 / 986420560 FAX: 986483297
 ALMACEN VINCOS: RUA OUTEIRO DO FERRO – POLIG. A PASAXE – VINCOS (GONDOMAR) – TFNO: 986467001
 ALMACEN PONTEAREAS: LOMBA, 81 – AREAS (PONTEAREAS) – TFNO: 986640283
 Mail: info@cabadacomercial.com / tecnicos@cabadacomercial.com / ponteareas@cabadacomercial.com
 Web: www.cabadacomercial.com



TARIFA DE PRECIOS

VIGUETA PRETENSADA

ARTICULOS	PVP* €/ML
VIGUETAS T-11 LISAS PARA CUBIERTA (Medida cortadas rectas)	
VIGUETA T-11 HASTA 3,00	5,13
VIGUETA T-11 DESDE 3,05 HASTA 4,00	5,20
VIGUETA T-11 DESDE 4,05 HASTA 5,00	5,52
VIGUETA T-11 DESDE 5,05 HASTA 6,00	6,30
VIGUETA T-11 DESDE 6,05	6,93

ARTICULOS	PVP* €/ML
VIGUETAS T-14 LISAS	
VIGUETA T-14 HASTA 3,00	5,58
VIGUETA T-14 DESDE 3,05 HASTA 4,00	5,90
VIGUETA T-14 DESDE 4,05 HASTA 5,00	6,37
VIGUETA T-14 DESDE 5,05 HASTA 6,00	6,92
VIGUETA T-14 DESDE 6,05	7,08

T-11 LISA

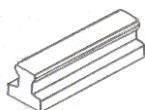

T-14



T-16

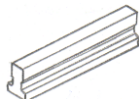

T-21

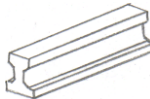

T-30

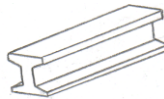

T-11 RUGOSAS

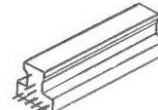

ARTICULOS	PVP* €/ML
VIGUETAS T-16 LISAS	
VIGUETA T-16 HASTA 3,00	6,07
VIGUETA T-16 DESDE 3,05 HASTA 4,00	6,50
VIGUETA T-16 DESDE 4,05 HASTA 5,00	7,05
VIGUETA T-16 DESDE 5,05 HASTA 6,00	7,45
VIGUETA T-16 DESDE 6,05	7,92
VIGUETA T-21 HASTA 8.50	13,60
VIGUETA T- 30	32,40

ARTICULOS	PVP* €/ML
VIGUETAS T-11 RUGOSAS PARA FORJADO (Medida contada con 8 cm de armadura a cada lado)	
VIGUETA T-11 HASTA 3,00	5,05
VIGUETA T-11 DESDE 3,05 HASTA 4,00	5,13
VIGUETA T-11 DESDE 4,05 HASTA 5,00	5,44
VIGUETA T-11 DESDE 5,05 HASTA 6,00	6,23
VIGUETA T-11 DESDE 6,05	6,86

PONTONES MADERA : 2,50 €/UD

(Se abonarán por el mismo importe a su devolución)

VIGUETAS PARA CUBIERTA intereje 1,2 m					
		LUCES MÁXIMAS DE UTILIZACION (m)			
		URALITA		URALITA+TEJA	
VIGUETA	MU (m KN)	SIMPLE	DOBLE	SIMPLE	DOBLE
T11-1	3.21	3.65	4.60	3.10	4.00
T11-2	3.45	3.80	4.80	3.20	4.15
T11-3	3.88	4.00	5.10	3.40	4.40
T11-5	4.32	4.25	5.35	3.60	4.60
T16-1	7.44	5.55	6.90	4.75	6.05
T16-2	8.44	5.90	7.35	5.05	6.45
T16-3	9.46	6.25	7.80	5.35	6.80
T21-1	16.91	7.90	9.65	6.80	8.50
T21-2	18.27	8.20	10.00	7.05	8.85
LUCES MÁXIMAS VIGUETAS T30 PARA ANCHOS DE BANDA DE 5 M CON CORREAS T16 SEPARADAS ENTRE SÍ 1,2 M (MAYORACIÓN 1,5)					
VIGUETA	MU (m KN)	ARMADO		URALITA	URALITA+TEJA
T30-1	44.52	5+0+1+1 = 7r6		6.35	5.50
T30-2	46.86	3+1+0+1 = 5r7		6.55	5.65
T30-3	52.22	5+0+1+1 = 7r7		6.90	5.95

POSTE RECTO Y DINTEL

ARTICULOS	PVP* €/ML
POSTE RECTO HASTA 4.00	4,66
DINTEL 10X8	4,43
DINTEL 14X8 HASTA 4 M	5,81
DINTEL 14X8 DESDE 4,25 M	6,12
<i>TANTO LOS POSTES RECTOS COMO LOS DINTELES SON CONSIDERADOS ELEMENTOS DE CIERRE, NO ESTANDO CONTEMPLADA SU UTILIZACION COMO CARGADEROS</i>	

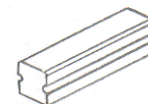

POSTE RECTO

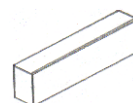

DINTEL

dic-23

* IVA NO INCLUIDO

OFICINA: C/CARACAS, Nº10 (36203) VIGO – TFNOS. 986421617 / 986420560
 ALMACEN VINCIOS: RUA OUTEIRO DO FERRO – POLIG. A PASAXE – VINCIOS (GONDOMAR) – TFNO: 986467001
 ALMACEN PONTEAREAS: LOMBA, 81 – AREAS (PONTEAREAS) – TFNO: 986640283
 Mail: info@cabadacomercial.com / tecnicos@cabadacomercial.com / ponteareas@cabadacomercial.com
 Web: www.cabadacomercial.com



TARIFA DE PRECIOS

Postes

ARTICULOS		PVP*
POSTE BRAZO RECTO	280 X 150	23,95 €/UD
	250 X 130*	25,30 €/UD
POSTE BRAZO 1 PIE	250 X 150	23,95 €/UD
	250 X 180*	26,25 €/UD
POSTE CIERRE BRAZO 245X40		22,15 €/UD
POSTE 250X16X14		28,70 €/UD
POSTE PERGOLA	255 X 16 X 16	29,80 €/UD
	300 X 16 X 16	35,15 €/UD
POSTE CIERRE LISO	20 X 20 X 250	40,00 €/UD
	20 X 20 X 300	47,25 €/UD
	25 X 25 X 250	63,50 €/UD
	25 X 25 X 300	70,70 €/UD
POSTE CIERRE LISO REFORZADO	20 X 20 X 250	45,10 €/UD
	20 X 20 X 300	53,30 €/UD
	25 X 25 X 250	67,50 €/UD
	25 X 25 X 300	76,65 €/UD
PASTA CIERRE	300 X 100 X 0.07	77,30 €/UD
	300 X 120 X 0.07	90,75 €/UD
	170 X 120 X 0.07	51,20 €/UD
POSTE CIERRE ACANALADO	20 X 20 X 150	29,95 €/UD
	20 X 20 X 250	45,10 €/UD
	20 X 20 X 300	53,30 €/UD
	20 X 20 X 350	59,10 €/UD

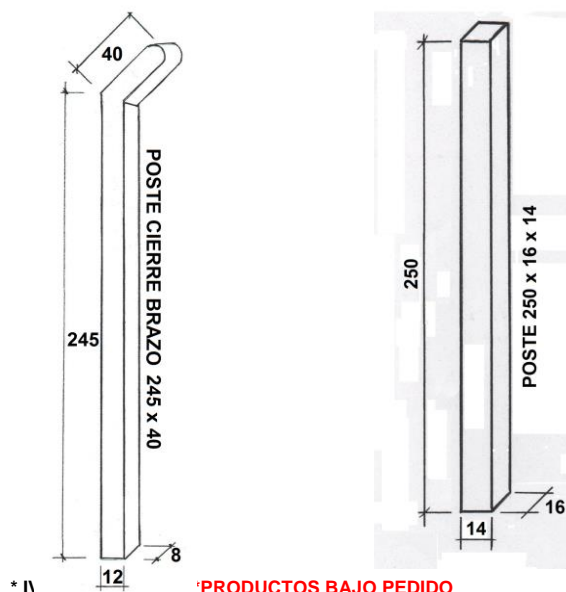
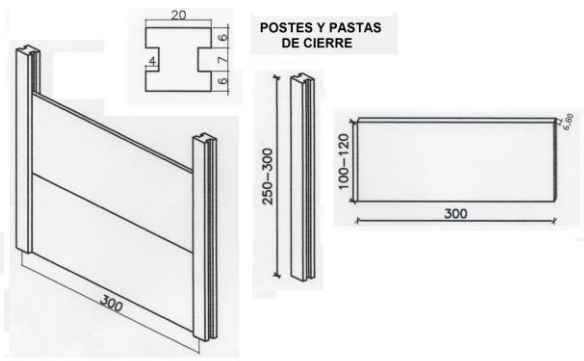
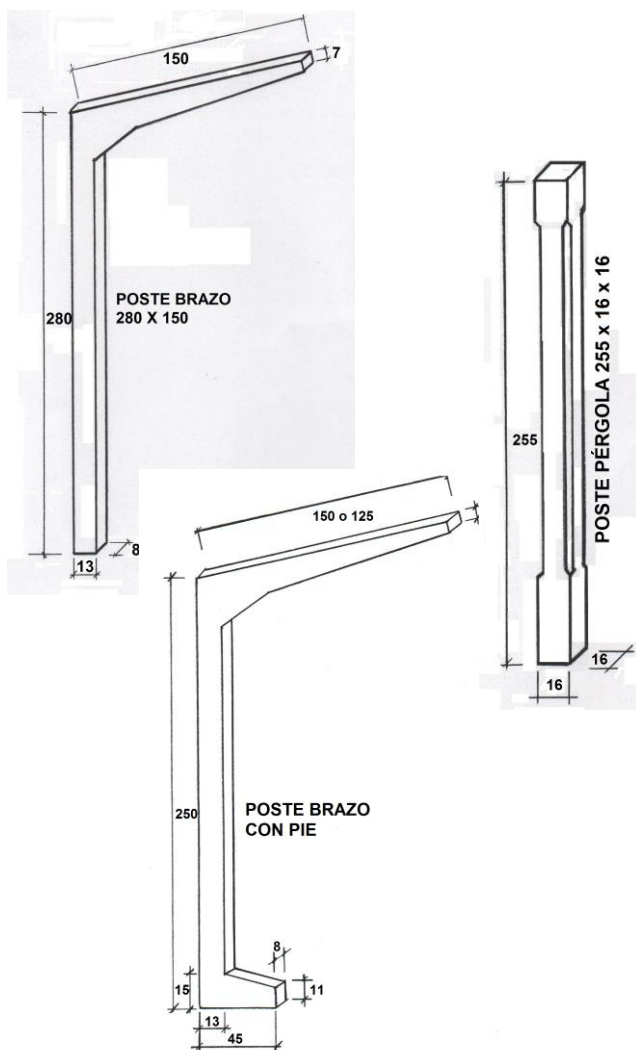

* II 'PRODUCTOS BAJO PEDIDO feb-24

OFICINA: C/CARACAS, Nº10 (36203) VIGO – TFNOS. 986421617 / 986420560 FAX: 986483297
ALMACEN VINCOS: RUA OUTEIRO DO FERRO – POLIG. A PASAXE – VINCOS (GONDOMAR) – TFNO: 986467001
ALMACEN PONTEAREAS: LOMBA, 81 – AREAS (PONTEAREAS) – TFNO: 986640283

Mail: info@cabadacomercial.com / tecnicos@cabadacomercial.com / ponteareas@cabadacomercial.com

Web: www.cabadacomercial.com



TARIFA DE PRECIOS

Aros de Pozo

ARTICULOS (medidas exteriores)	PVP*
ARO DE POZO 120X50X7	41,90 €/UD
ARO DE POZO 150X33X7	43,15 €/UD
ARO DE POZO 180X33X7	44,15 €/UD

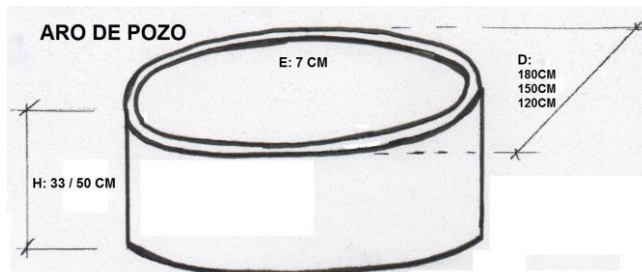

Tapas de Pozo

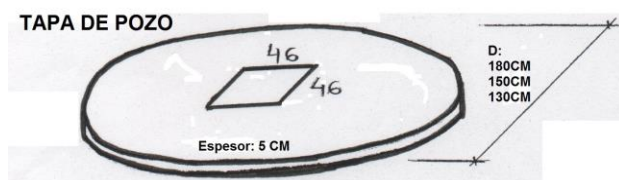

ARTICULOS (medidas exteriores)	PVP*
TAPA POZO 120X5	34,05 €/UD
TAPA POZO 130X5	34,05 €/UD
TAPA POZO 150X5	42,80 €/UD
TAPA POZO 180X5	58,70 €/UD
TAPA POZO REFORZADA 120	47,20 €/UD
TAPA POZO REFORZADA 130	47,20 €/UD
TAPA POZO REFORZADA 150	67,90 €/UD
TAPA POZO REFORZADA 180	90,80 €/UD

Tapas de Nicho

ARTICULOS	PVP*
TAPA NICH0 HORMIGÓN DE 64X69X3	10,20 €/UD
TAPA NICH0 HORMIGÓN DE 69X69X3	10,20 €/UD
TAPA NICH0 ARLITA DE 70X80X3	12,35 €/UD
TAPA NICH0 NEOPOR DE 70X80X3	12,35 €/UD
TAPA NICH0 NEOPOR DE 59X69X3	10,50 €/UD

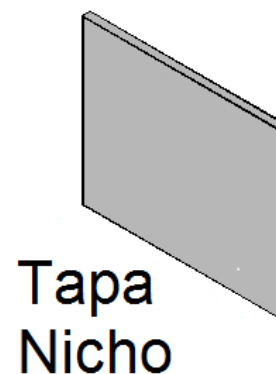

* IVA NO INCLUIDO

feb-24



TARIFA DE PRECIOS

BLOQUE DE CIERRE				
Dimensiones	Ud/palet	Kg/ud	Piezas/m2	PVP* (€/UD)
50 x 25 x 09	100	14	8	0,81
50 x 25 x 12	80	15	8	0,83
50 x 25 x 15	60	17.5	8	0,98
50 x 25 x 20	50	19	8	1,17



BLOQUE DE MURO				
Dimensiones	Ud/palet	Kg/ud	Piezas/m2	PVP* (€/UD)
50 x 20 x 20	50	18.5	10	1,18
50 x 20 x 25	40	20	10	1,24



BORDILLO JARDIN	
Dimensiones	PVP* (€/UD)
50 X 22 X 7 MACHIEMBRADO	1,95



PALET DE MADERA	14,00 €/UD
------------------------	-------------------

ARQUETA CEMENTO			
SIN FONDO		CON FONDO	
MEDIDA	PVP* (€/UD)	MEDIDA	PVP* (€/UD)
30X30X30	Consultar	30X30X30	Consultar
40X40X40	Consultar	40X40X40	Consultar
50X50X50	Consultar	50X50X50	Consultar
60X60X60	Consultar	60X60X60	Consultar
80X80X80	Consultar	80X80X80	Consultar
100X100X100	Consultar	100X100X100	Consultar



ARTÍCULO	PVP* (€/UD)
MARCO Y TAPA ARQUETA 30	Consultar
MARCO Y TAPA ARQUETA 40	Consultar
MARCO Y TAPA ARQUETA 50	Consultar
MARCO Y TAPA ARQUETA 60	Consultar
MARCO Y TAPA ARQUETA 80	Consultar
MARCO Y TAPA ARQUETA 100	Consultar

* IVA NO INCLUIDO

ene-24

OFICINA: C/CARACAS, Nº10 (36203) VIGO – TFNOS. 986421617 / 986420560 FAX: 986483297
 ALMACEN VINCOS: RUA OUTEIRO DO FERRO – POLIG. A PASAXE – VINCOS (GONDOMAR) – TFNO: 986467001
 ALMACEN PONTEAREAS: LOMBA, 81 – AREAS (PONTEAREAS) – TFNO: 986640283
 Mail: info@cabadacomercial.com / tecnicos@cabadacomercial.com / ponteareas@cabadacomercial.com
 Web: www.cabadacomercial.com



TARIFA DE PRECIOS

DEPURACIÓN DE AGUAS RESIDUALES (PREFABRICADOS DE HORMIGÓN)

ARTÍCULO	COTAS DE MONTAJE (CM)				PVP* (€/UD)
	Altura Total (HT)	Altura entrada (H)	Ø colector (Ø)	Ø máximo (D)	
DECANTADOR DIGESTOR					
ADD-100-1	230	195	15	117	CONSULTAR
ADD-100-2	280	245	15	117	CONSULTAR
ADD-100-3	330	295	15	117	CONSULTAR
ADD-125-1	225	195	15	143	CONSULTAR
ADD-125-2	275	245	15	143	CONSULTAR
ADD-125-3	325	295	15	143	CONSULTAR

ARTICULO	COTAS DE MONTAJE (CM)							PVP* (€/UD)
	Altura Total (HT)	Altura entrada (H)	Altura Relleno (HR)	Ø colector (Ø)	Diámetro			
					Tot DT	Ext DE	Int DI	
POZO FILTRANTE								
PF 100-1	125	90	60	15	117	109	100	CONSULTAR
PF 100-2	175	140	110	15	117	109	100	CONSULTAR
PF 100-3	225	190	160	15	117	109	100	CONSULTAR
PF 125-1	125	90	60	15	143	136	125	CONSULTAR
PF 125-2	175	140	110	15	143	136	125	CONSULTAR
PF 125-3	225	190	160	15	143	136	125	CONSULTAR

ARTICULO	COTAS DE MONTAJE (CM)						PVP* (€/UD)
	Altura Total HT	Altura entrada HE	Altura salida HS	Colector Ø	Medidas		
					Ext	Int	
SEPARADOR DE GRASA SG – 60X60X114							
	114	90	85	100	60	52	CONSULTAR

ARTICULO	COTAS DE MONTAJE (CM)								PVP* (€/UD)
	Altura			Ø colector (Ø)	Longitud		Anchura		
	Total HT	Entrada HE	Salida HS		Total LT	Int LI	Total AT	Int AI	
ARQUETA CON REJA DE DESBASTE									
AR-60X60X60-RD	60	SN	SN	SN	60	52	60	52	CONSULTAR
AR-80X80X80-RD	80	SN	SN	SN	80	70	80	70	CONSULTAR

(SN: SEGÚN NECESIDADES)

* IVA NO INCLUIDO

oct-22

OFICINA: C/CARACAS, Nº10 (36203) VIGO – TFNOS. 986421617 / 986420560 FAX: 986483297
 ALMACEN VINCIOS: RUA OUTEIRO DO FERRO – POLIG. A PASAXE – VINCIOS (GONDOMAR) – TFNO: 986467001
 ALMACEN PONTEAREAS: LOMBA, 81 – AREAS (PONTEAREAS) – TFNO: 986640283
 Mail: info@cabadacomercial.com / tecnicos@cabadacomercial.com / ponteareas@cabadacomercial.com
 Web: www.cabadacomercial.com



TARIFA DE PRECIOS

ARTÍCULO	PVP* €/UD)
FOSA SÉPTICA 140x100	CONSULTAR
FOSA SÉPTICA 230x140	CONSULTAR
ARO 80x50x4,5	CONSULTAR
ARO 100x50x4,5	CONSULTAR
ARO 125x50x5,5	CONSULTAR
ARO 150x50x6	CONSULTAR
ARO 200x40x7	CONSULTAR

ESQUEMA DE INSTALACIÓN CON DECANTADOR PRIMARIO Y POZO FILTRANTE

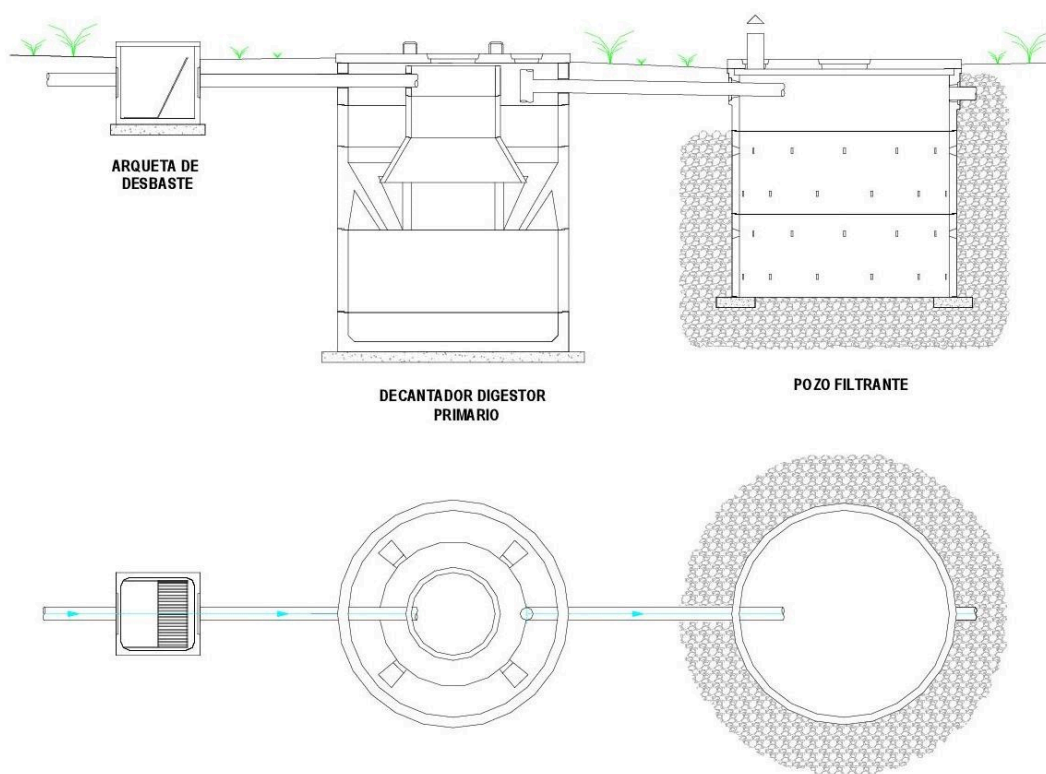

PRU	Fecha	Nombre	DECANTADOR DIGESTOR 1º + POZO FILTRANTE	Escala
	DB:	G.I.S.S.		
	Código:			
	Nombre:			
HERDANZA S.L.	INSTALACION		Formato	

* IVA NO INCLUIDO

oct-22



TARIFA DE PRECIOS

Poliestireno Extrusionado - CHOVAFOAM -

ARTICULO		PVP €/M3	PVP €/M2	PVP* (€/UD)
CÁMARA DE AIRE, FACHADAS Y SUELOS – ACABADO MACHIHEMBRADO				
81951A	250 H40 DE 2600X600X40	104,39	4.176	6.51
81952A	250 H50 DE 2600X600X50		5.220	8.14
81954A	250 H60 DE 2600X600X60		6.263	9.77
81955A	250 H80 DE 2600X600X80		8.351	13.03
CUBIERTA INVERTIDA – ACABADO MEDIA MADERA				
81910A	300 M40 DE 1250X600X40	104,39	4.176	3.13
81915A	300 M50 DE 1250X600X50		5.220	3.91
81920A	300 M60 DE 1250X600X60		6.263	4.70
81930A	300 M80 DE 1250X600X80		8.351	6.26
SUELOS – CORTE RECTO				
81961A	250 S40 DE 1250X600X40	104,39	4.176	3.13
81962A	250 S50 DE 1250X600X50		5.220	3.91
81963A	250 S60 DE 1250X600X60		6.263	4.70
CUBIERTA INCLINADA – MEDIA MADERA ACANALADO				
81980A	300 R40 DE 1250X600X40		A CONSULTAR	
81985A	300 R50 DE 1250X600X50			
81986A	300 R60 DE 1250X600X60			

ESPESOR XPS	UD/PQ
40 MM	9
50 MM	8
60 MM	7
80 MM	5
100 MM	4



EN VIGOR 6 DE SEPTIEMBRE DE 2023

* IVA NO INCLUIDO

sep-23

OFICINA: C/CARACAS, Nº10 (36203) VIGO – TFNOS. 986421617 / 986420560
 ALMACEN VINCIOS: RUA OUTEIRO DO FERRO – POLIG. A PASAXE – VINCIOS (GONDOMAR) – TFNO: 986467001
 ALMACEN PONTEAREAS: LOMBA, 81 – AREAS (PONTEAREAS) – TFNO: 986640283
 Mail: info@cabadacomercial.com / tecnicos@cabadacomercial.com / ponteareas@cabadacomercial.com
 Web: www.cabadacomercial.com



TARIFA DE PRECIOS



Lana Mineral

	REF.	Espesor mm	Ancho m	Largo m	Panel/Rollo	Ud/Pqte	M2/Pqte	€/m2	PVP* €/Paquete
APLICACIÓN: TABIQUES, MEDIANERAS Y TRASDOSADOS									
TERRA BASE	2140335	50	0.40	13.50	ROLLO	3	16.20	2,399	38,86*
	2140338	60	0.40	10.80	ROLLO	3	12.96	2,780	36,03*
	2140340	75	0.40	8.10	ROLLO	3	9.72	3,816	37,10*
	2141651	50	0.60	1.35	PANEL	15	12.15	2,461	27,91
	2141653	75	0.60	1.35	PANEL	10	8.10	4,444	36,00*
APLICACIÓN: MEDIANERAS Y TRASDOSADOS. FALSOS TECHOS									
TERRA PLUS 32	2141708	40	0.60	1.35	PANEL	15	12.15	5,388	65,47*
	2141731	60	0.60	1.35	PANEL	10	8,10	8,003	64,83*
APLICACIÓN: TRASDOSADOS									
TERRA MUR	2141740	50	0.60	1.35	PANEL	13	10.53	4,769	50,22*
APLICACIÓN: SUELOS FLOTANTES									
TERRA SOL	2131765	20	0.60	1.20	PANEL	17	12.24	6,031	73,81*
APLICACIÓN: FACHADA VENTILADA. FALSOS TECHOS									
TERRA VENTO	2142653	50	0.60	1.35	PANEL	12	9.72	7,542	73,31*
	2142695	100	0.60	1.35	PANEL	6	4,86	13,380	65,05*
APLICACIÓN: FACHADA VENTILADA									
TERRA VENTO PLUS	2142700	50	0.60	1.35	PANEL	10	8.10		consultar
	2142701	60	0.60	1.35	PANEL	9	7.29		consultar
	2142705	80	0.60	1.35	PANEL	7	5.67		consultar
APLICACIÓN: AISLAMIENTO ENTRE TABIQUILLOS									
TERRA MANTA PAPEL	2062020	60	1.20	12.50	ROLLO	1	15.00	2,954	46,50
	2062021	80	1.20	11.00	ROLLO	1	13.20	3,796	52,62
	2062022	100	1.20	8.50	ROLLO	1	10.20	4,980	50,79*
	2062024	120	1.20	6.50	ROLLO	1	7.80	5,947	46,38*
APLICACIÓN: AISLAMIENTO EXTERIOR CONDUCTOS METÁLICOS DE CLIMATIZACION									
AIR MANTA ALU	2141026	50	1.20	16.50	ROLLO	1	19,80	4,991	98,83*

* Precio hasta fin stock



REF.	DESCRIPCIÓN	PVP*
9081	ROCFLAM PANEL CHIMENEA 1000X600X30	9,80 €/UD



Lana de Roca

REF.	MEDIDA	UD/PQTE	M2	Aplicación	PVP*
PANEL SEMI-RIGIDO ALPHAROCK E225 D.70 KG					
3901	1.35M X 0.60M X 60MM	7	5.67	(Falso Techo, Fachada Ventilada, Trasdosados)	consultar

* IVA NO INCLUIDO

abr-24

OFICINA: C/CARACAS, Nº10 (36203) VIGO – TFNOS. 986421617 / 986420560
 ALMACEN VINCOS: RUA OUTEIRO DO FERRO – POLIG. A PASAXE – VINCOS (GONDOMAR) – TFNO: 986467001
 ALMACEN PONTEAREAS: LOMBA, 81 – AREAS (PONTEAREAS) – TFNO: 986640283
 Mail: info@cabadacomercial.com / tecnicos@cabadacomercial.com / ponteareas@cabadacomercial.com
 Web: www.cabadacomercial.com



TARIFA DE PRECIOS



Aislamiento Reflectivo



REF.	ARTICULO	Ancho M	Largo M	Espesor MM	M2	Aplicación	PVP*
POL1	ONE	1.20	40	4	48	Suelo	193.70 €/Rollo
PRF1	RF1	1.20	35		42		114,35 €/Rollo
SP02P	SUPER	1.20	40	4	48	Cubiertas y Paredes	205,37 €/Rollo
PRF2	RF2	1.20	35		42		130.69 €/Rollo
PB1	BIG	1.20	30	4	36	Paredes y Fachadas (cámara aire, cub. inclinadas, techos y F. ventiladas)	171.53 €/Rollo
PU2	ULTRA	1.20	20	16	24		256,71 €/Rollo
PRPT	RPT	0.60	2	4	20 Tiras	Cantos y Frentes Forjado	175,03 €/Pqte
PRPTT	RPT	0.60	2	4	Tira		8,75 €/Ud
PBLH	BLH-B	1.20	30	8	36	Bajo Losa Hormigón-Suelos-Forjados	203,04 €/Rollo
BLHF	BLH-F	1.20	30	8	36	Aislamiento de suelos, forjados y cubiertas planas	182,03 €/Rollo
PF	CINTA POLYFIX	75MM	50			Sellado de Juntas	7,29 €/Rollo
PCP	KIT CAJÓN PERSIANAS	0.25	1.20				10,48 €/Ud
P3L	POLYNUM 3L	1.20	40	10	48	Multicapa	CONSULTAR
P5L	POLYNUM 5L	1.20	30	20	36		CONSULTAR
P7L	POLYNUM 7L	1.20	20	30	24		CONSULTAR



ARTICULOS		PVP* (€/UD)
ARLITA LECA DUR BB (2-10 mm)	SACO 50 LT (20 sacos/m3)	9,10
	SACO 1.5 M3	238,65



ARTICULOS	PVP* (€/UD)
PERLITA EXPANDIDA – Saco 166 lt (6 sacos/m3) – aislamiento –	8,95



ENTRA EN VIGOR EL 18 DE SEPTIEMBRE DE 2023

* IVA NO INCLUIDO

ene-24

OFICINA: C/CARACAS, Nº10 (36203) VIGO – TFNOS. 986421617 / 986420560 / 667648061
 ALMACEN VINCOS: RUA OUTEIRO DO FERRO – POLIG. A PASAXE – VINCOS (GONDOMAR) – TFNO: 986467001
 ALMACEN PONTEAREAS: LOMBA, 81 – AREAS (PONTEAREAS) – TFNO: 986640283
 Mail: info@cabadacomercial.com / tecnicos@cabadacomercial.com / ponteareas@cabadacomercial.com
 Web: www.cabadacomercial.com



TARIFA DE PRECIOS

Poliestireno Expandido

PLANCHAS ESTÁNDAR – COLOR BLANCO					
Tipo	Densidad	Dimensiones (cm)	Ud/pqte	Conductividad (W/(m·K))	PVP* (€/UD)
III	13.5-15	250 X 100 X 001	40	0.038	2,00
		250 X 100 X 002	20		3,72
		250 X 100 X 003	14		5,58
		250 X 100 X 004	10		7,44
		250 X 100 X 005	8		9,30
IV	18-20	250 X 100 X 001	40	0.036	2,54
		250 X 100 X 002	20		4,79
		250 X 100 X 003	14		7,19
		250 X 100 X 004	10		9,58
		250 X 100 X 005	8		11,98

**Bovedillas
Poliestireno:
consultar
en pág. 26**

PLANCHAS ONDA – COLOR BLANCO						
Tipo	Densidad	Variedad	Dimensiones (cm)	Ud/pqte	Conductividad (W/(m·K))	PVP* (€/UD)
IV	18-20	NORMAL	250 x 097	8	0.036	15,17
		C/ENCAJE	250 x 105	8		16,42
		DOBLE	250 x 098 x 004	8		12,14
		DOBLE	250 x 098 x 005	8		15,17

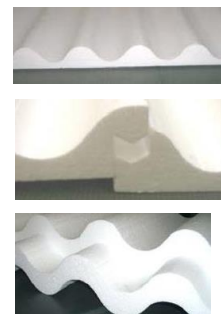

PLANCHAS PARA AISLAMIENTO TÉRMICO EXTERIOR - SATE -					
PLANCHA – COLOR BLANCO –			PLANCHA GRAFITADA (Gris oscuro)		
Tipo IV	Densidad: 18-20	Conductividad: 0.036	Tipo PN16	Densidad: 16	Conductividad: 0.032
Dimensiones (cm)	Ud/pqte	PVP* (€/UD)	Dimensiones (cm)	Ud/pqte	PVP* (€/UD)
100 X 050 X 001	100	0,47	100 X 050 X 001	100	0,54
100 X 050 X 002	50	0,94	100 X 050 X 002	50	1,07
100 X 050 X 003	34	1,42	100 X 050 X 003	34	1,61
100 X 050 X 004	24	1,89	100 X 050 X 004	24	2,15
100 X 050 X 005	20	2,36	100 X 050 X 005	20	2,68
100 X 050 X 006	16	2,83	100 X 050 X 006	16	3,22
100 X 050 X 007	14	3,30	100 X 050 X 007	14	3,75
100 X 050 X 008	12	3,78	100 X 050 X 008	12	4,29
100 X 050 X 010	10	4,72	100 X 050 X 010	10	5,36

OTROS PRODUCTOS DE EPS	
PERLA P-I (D.9-10) SACO 0.50 M3	31,46 €/UD
PERLA GRAFITADA (D.15-17) SACO 0.5 M3	62,21 €/UD
POLIESTIRENO MOLIDO EPS SACO 0.5 M3	17,16 €/UD



DOSIFICACIÓN PERLITA PARA HORMIGONERA DE 250 LT * mezclar durante 5 minutos *			
Densidad Hormigón	200 Kg/m3	250 Kg/m3	300 Kg/m3
Perlita	200 L	200 L	200 L
Cemento	40 Kg	50 Kg	60 Kg
Agua	20 L	25 L	30 L

* IVA NO INCLUIDO

oct-23



TARIFA DE PRECIOS

Resto accesorios SATE ver pag:53

ARTICULOS			PVP* (€/UD)
300620	MALLA ESPECIAL AISLANTE 160 GR – 1MX50M (50M2)	Color blanco / Realizada en fibra de vidrio Se utiliza en sistemas técnicos aislantes para evitar la formación de grietas en la fachada	44.33
ZIN331664E	ANGULO EN PVC CON RED	Con red de fibra de vidrio Se utiliza para que haya una resistencia uniforme en todo el aislamiento del edificio	1,50
ZIN331665E	ANGULO EN ALU CON RED		1,74



MALLA ESPECIAL AISLANTE

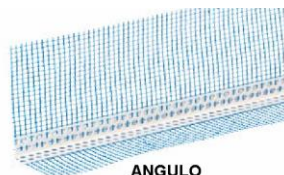

ANGULO

ARTICULOS			PVP* (€/UD)
981139	FIJADOR AISLAMIENTO 10X70	Fabricado en polipropileno Diámetro de roseta: 50 mm	0,09*
57611	FIJADOR AISLAMIENTO SPIT 10x95		0,25
60001	FIJADOR AISLAMIENTO SPIT 10x115		0,26
57630	FIJADOR AISLAMIENTO SPIT 10x135		0,37
TER112223	FIJADOR AISLAMIENTO 10x150		0,15*
TER112224	FIJADOR AISLAMIENTO 10x180		0,27*
FS8X70	FIJADOR SIMPLE 8X70	Fabricado en polipropileno Roseta: 60 mm Ø 6	0,10
2230	TACO PARA PANEL EXTRUSO 75X30MM	Fabricado en polipropileno Taco expansión con cabeza de 30mm Para anclajes de paneles aislantes	0,04*

* hasta fin existencias



FIJADOR AISLAMIENTO



FIJADOR SIMPLE



TACO PARA PANEL EXTRUSO

ARTICULOS			PVP* (€/UD)
PERFIL ARRANQUE GOTERÓN			
PA40G	40MMx2.5M	Fabricado en aluminio Base de salida con terminal anti-goteo Base para la colocación de los paneles aislantes en EPS, como primer paso del SATE	4,35
PARR50	50MMx2.5M		5,05
PA60G	60MMx2.5M		5,83
PARR8	80MMx2.5M		7,10
ZIN321678	50MMx2.5M	Perfil CLIP esquinero con red arranque, para mejorar goterón.	7,54

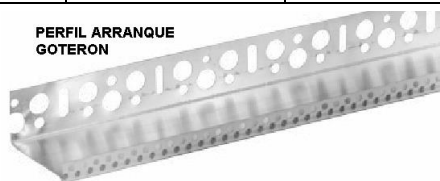

PERFIL ARRANQUE GOTERÓN

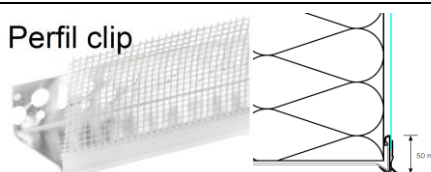

Perfil clip

* IVA NO INCLUIDO

nov-23



TARIFA DE PRECIOS



IMPERMEABILIZACIÓN BITUMINOSA

SBS- POLITABER Láminas de betún modificado

Código	Artículo	Armadura	M2/Rollo	PVP*
Polietileno / polietileno – No protegida				
31060	VEL 30	Fibra de Vidrio	12	42,04 €/Rollo
32150	POL PY 30	Fieltro de Poliéster	12	50,80 €/Rollo
32155	POL PY 40		10	50,62 €/Rollo
37650	BANDA 33 (12x0.33)		12 ML	25,57 €/Rollo
37450	COMBI 40 – antiradón -	F. Poliéster Reforzado	10	51,05 €/Rollo
37444	COMBI 48 – antiradón -	F. Poliéster Reforzado	8	47,48 €/Rollo
Gránulo/ polietileno – Autoprottegida				
31319	VEL 40/G GRIS OSC	Fibra de Vidrio	10	40,61 €/Rollo
31400	VEL 40/G ROJO OSCURO			44,33 €/Rollo
37467	COMBI 40/G GRIS OSCURO	Fieltro de Poliéster	8	50,91 €/Rollo
37462	COMBI 40/G ROJO OSC			55,77 €/Rollo
37468	COMBI 50/G GRIS.OSC			47,82 €/Rollo
37464	COMBI 50/G ROJO OSC			53,20 €/Rollo
37480	COMBI GARDEN	F. Poliéster Reforzado	8	62,35 €/Rollo

APP- ChovAPLAST Láminas de betún aditivado

Código	Artículo	Armadura	M2/Rollo	PVP*
Polietileno – No protegida				
14001	VEL 30	Fibra de Vidrio	12	30,37 €/Rollo
14005	VEL 40		10	32,75 €/Rollo
Aluminio/ polietileno				
14060	ALU 30 NATURAL	Aluminio natural	12	55,94 €/Rollo

Código	Artículo	Aplicación	Presentación (m)	PVP*
CINTA AUTOADHESIVA – RAPID BRIC –				
60020	RAPID BRIC C10 NATURAL		12 x 0.10	15,62 €/Rollo
60030	RAPID BRIC C15 NATURAL		12 x 0.15	19,22 €/Rollo
60060	RAPID BRIC C30 NATURAL		12 x 0.30	35,35 €/Rollo
60310	RAPID BRIC C10 ROJO		12 x 0.15	17,67 €/Rollo
60320	RAPID BRIC C15 ROJO		12 x 0.15	27,11 €/Rollo
60330	RAPID BRIC C30 ROJO		12 x 0.30	46,85 €/Rollo

Láminas sintéticas impermeabilizantes PVC

Código	Artículo	Presentación (m)	PVP*
38026	CHOVIPOL RP 1.2 INTEMPERIE	2,10X20	CONSULTAR

* IVA NO INCLUIDO

mar-24



TARIFA DE PRECIOS

IMPERMEABILIZACIÓN BITUMINOSA

PLACAS BITUMINOSAS

TEGOLA AMERICANA



Código	Artículo	Armadura	Presentación	PVP*
43006	TEGOLA STANDARD NEGRO (NUEVA)	Fibra de vidrio	3,05 M2	36,64 €/Pqte
43016	TEGOLA STANDARD VERDE (NUEVA)	Fibra de vidrio	3,05 M2	36,64 €/Pqte
43106	TEGOLA CASTOR NEGRO (NUEVA)	Fibra de vidrio	3,05 M2	38,86 €/Pqte
43116	TEGOLA CASTOR VERDE (NUEVA)	Fibra de vidrio	3,05 M2	38,86 €/Pqte

***BAJO PEDIDO**

IMPRIMACIONES Y EMULSIONES

Código	Artículo	Presentación	PVP*
55025E	SUPERMUL 25	25 KG	40,04 €/UD
55125	SUPERELAST 25	25 KG	59,70 €/UD
55721	PRIMER EAL 25	25 KG	54,34 €/UD



SLURRYS TRADICIONALES

Código	Artículo	Presentación	PVP*
84825	ASFALT SL NEGRO	50 KG	37,18 €/UD
84822	ASFALT RAPID NEGRO 25KG	25 KG	14,66 €/UD



ACCESORIOS PARA LA IMPERMEABILIZACIÓN

Código	Artículo	Presentación	PVP*
84020	CAZOLETA NORMAL EDPM 90		8,95 €/UD
84080	CAZOLETA LATERAL		19,69 €/UD
84090	PARAGRAVILLAS		1,79 €/UD
86035	GRANULO MINERAL ROJO OSC	25 KG	13,94 €/UD



* IVA NO INCLUIDO

mar-24

OFICINA: C/CARACAS, Nº10 (36203) VIGO – TFNOS. 986421617 / 986420560

ALMACEN VINCOS: RUA OUTEIRO DO FERRO – POLIG. A PASAXE – VINCOS (GONDOMAR) – TFNO: 986467001

ALMACEN PONTEAREAS: LOMBA, 81 – AREAS (PONTEAREAS) – TFNO: 986640283

Mail: info@cabadacomercial.com / tecnicos@cabadacomercial.com / ponteareas@cabadacomercial.com

Web: www.cabadacomercial.com

TARIFA DE PRECIOS



IMPERMEABILIZACIÓN LIQUIDA

REVESTIMIENTOS IMPERMEABILIZANTES

Código	Artículo	PVP*
75261	CHOVATEC ANTIG. FIBRATADO ROJO 20 KG	52,91 €/UD
75262	CHOVATEC ANTIG. FIBRATADO GRIS 20 KG	
75263	CHOVATEC ANTIG. FIBRATADO BLANCO 20 KG	
75256	CHOVATEC ANTIG. FIBRATADO ROJO 5 KG	15,02 €/UD
75257	CHOVATEC ANTIG. FIBRATADO GRIS 5 KG	
75258	CHOVATEC ANTIG. FIBRATADO BLANCO 5 KG	



ARMADURAS Y BANDAS DE REFUERZO

Código	Artículo	Presentación	PVP*
82220	MALLA 50 DE REFUERZO (Fibra de vidrio) 55 gr/m2	50x1	43,62 €/UD

DRENAJES Y GEOTEXTILES

LÁMINAS DRENANTES

Código	Artículo	Presentación	PVP*
83164	CHOVADREN	2X30	88,37 €/UD
83175	CHOVADREN DD (con geotextil)	2x20	133,85 €/UD
83179	CHOVADREN 20 GARDEN	2X20	300,87 €/UD
83180	ROSETA Y CLAVOS CHOVADREN	200 UD	41,10 €/CAJA



GEOTEXTILES

Código	Artículo	Peso (g/m2)	Presentación (m)	PVP*
83253	GEOFIM PP 125 – 15	125	1.83 X 100	209,35 €/UD
83257	GEOFIM PP 200 – 23	200		350,66 €/UD



ChovATERM

LÁMINA IMPERMEABILIZANTE CON POLIESTIRENO EXTRUIDO



Código	Artículo	Espesor	PVP*
35002	XPS 40 COMBI 50/G GRIS O	40 mm	126,64 €/UD
34996	XPS-50 POL PY 30 5X1	50 mm	102,89 €/UD

* IVA NO INCLUIDO

mar-24



TARIFA DE PRECIOS



IMPERMEABILIZANTES LÍQUIDOS

Código	Artículo	Peso	Color	PVP*
75200E	CHOVASTAR PREPARADOR SUPERFICIES	4 KG	NEGRO	11,61 €/UD
78301	CHOVASTAR COLA AISLAMIENTOS Instalación de mat. Multicapa y aislantes fibrosos (CHOVACUSTIC, CHOVAPREN)	5 LT		27,24 €/UD
58100	CHOVASTAR COLA AISLAMIENTOS Instalación de mat. Multicapa y aislantes fibrosos (CHOVACUSTIC, CHOVAPREN)	20 LT		106,11 €/UD



* IVA NO INCLUIDO

mar-24

OFICINA: C/CARACAS, Nº10 (36203) VIGO – TFNOS. 986421617 / 986420560
 ALMACEN VINCOS: RUA OUTEIRO DO FERRO – POLIG. A PASAXE – VINCOS (GONDOMAR) – TFNO: 986467001
 ALMACEN PONTEAREAS: LOMBA, 81 – AREAS (PONTEAREAS) – TFNO: 986640283
 Mail: info@cabadacomercial.com / tecnicos@cabadacomercial.com / ponteareas@cabadacomercial.com
 Web: www.cabadacomercial.com



TARIFA DE PRECIOS



IMPERMEABILIZACIÓN Y AISLAMIENTO

AISLAMIENTO ACÚSTICO A RUIDO AÉREO

LÁMINAS VISCOELÁSTICAS DE ALTA DENSIDAD				
Código	Artículo	Espesor	Dimensiones	PVP*
56002	VISCOLAM 65	4 mm	5.5 x 1	29,97 €/UD
56005	VISCOLAM Autoadhesiva Plancha	4 mm	1.2 x 1	9,63 €/UD
56007	VISCOLAM Autoadhesiva Rollo	4 mm	5.5 x 1	41,29 €/UD



COMPUESTOS Y PANEL MULTICAPA				
Código	Artículo	Espesor	Dimensiones	PVP*
56003	PANEL CHOVACUSTIC 65 LR 70/4	44 mm	1 x 0.60	14,06 €/UD
56304	CHOVACUSTIC 35 FIELTEX	18 mm	5.5 x 1	48,21 €/UD
56303	CHOVACUSTIC 65 FIELTEX	20 mm	5.5 x 1	62,92 €/UD
58185	ELASTOBAND BAJANTES (altura: 420 mm x longitud 10 m)			53,48 €/UD
58130	BANDA DESOLARIZANTE 100	4 mm	5,5 M x 100 mm	5,66 €/UD



AGLOMERADOS				
Código	Artículo	Espesor	Dimensiones	PVP*
81615	CHOVAPREN 80/4 (P.multiaislante)	40 mm	2 x 1	17,22 €/UD
81617	CHOVAPREN 110/2 (P.multiaislante)	20 mm	2 x 1	12,93 €/UD



PANEL ABSORBENTE			
Código	Artículo	Dimensiones (placa)	PVP*
81551	CHOVACUSTIC DECO MARINA (paquete de 10 placas)	500 x 500 x 30	Consultar €/paquete
81552	CHOVACUSTIC DECO PIRÁMIDE (paquete de 8 placas)	450 x 450 x 43	Consultar €/paquete

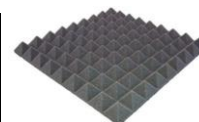

AISLAMIENTO ACÚSTICO A RUIDO DE IMPACTO

Código	Artículo	Dimensión (m)	PVP*
82450	CHOVAIMPACT 3 mm	150 x 1.5	109,40 €/UD
82460	CHOVAIMPACT 5 mm	100 x 1.5	111,54 €/UD
82465	CHOVAIMPACT 10 mm	42 x 1.2	109,40 €/UD
58050	CHOVAIMPACT PLUS 9 mm	45 x 1.5	254,83 €/UD



* IVA NO INCLUIDO

mar-24



TARIFA DE PRECIOS



		KG	UD/P	APLICACIÓN	PVP* (€/ud)	
MP	MAX PLUS	20	60	Escayola-perlita Aplicación manual	4,72	
PEM	PERLISCAYOLA MANUAL	20	60		4,95	
MAF10	MAX FINO	10	60	Yeso especial de terminación en base escayola que proporciona un acabado fino y fácil lijado aplicado sobre los yesos.	3,45	
MAF17		17	64		4,48	
YG	YESO RAPIDO	20	64	Yeso manual para guarnecidos int (paredes, techos), ligante de ladrillos en tabiquería int y recibido de elementos como marcos, caja de luz, ...	3,57	
YC5	YESO COLA	5	105	Pegamento moldura	2,95	
YC10		10	120		3,75	
YC25		25	48		8,85	
ESC17	ESCAYOLA ESYEDEBRO	17	64	Escayola - nuevo envase	2,78	
GT	GOTELIS	15	72	Alisado paredes – GOTELÉ	10,05	
UM6	UNI MAX	6		Puente unión yeso	22,40	
HC	HIDRÓXIDO DE CAL	20	50		7,70	
PJ1H	PASTA JUNTAS ESYEDEBRO	1 H	20	Pasta juntas para PLADUR	12,97	
PJ2H		2 H	10		120	7,25
PJ4H		4 H	25		48	16,30
PJ30		30 MÍN	10		120	7,25
PALP	PALETS DE MADERA (se abonarán por el mismo importe a su devolución)				12,00	



		Kg	Ud/P	Aplicación	PVP* (€/ud)
	RUBÍ	25	48	Yeso aligerado con perlita B4 (YMP/A).	5,20
	PLATINUM	20	60	Yeso aligerado altas prestaciones aligerado con perlita	5,57
	CORAL+	20	64	Yeso monocapa mecánica sin aligerar	3,90
Manual	JADE	20	64	Yeso fraguado RAPIDO / Albañilería y pequeñas reparaciones	3,25
	PERLA	17	72	Yeso aligerado con perlita (altas prestaciones) Guarnecido de tabiques y techos en int.	3,45
	DIAMANTE	20	64	Yeso ALTA DUREZA (altas prestaciones) Guarnecido de tabiques y techos en int. Indicado para edificios con alto tránsito (colegios, hospitales, restaurantes)	3,90
Fino	AMATISTA	20	64	Yeso de terminación, de aplicación manual	7,20
	AMATISTA PLUS	20	64	Yeso FINO de ACABADO para yesos manuales. Terminación trabajos realizados con yesos de proyección.	8,65
Masillas	CRISTAL TOTAL	15	40	Masilla de fraguado rápido para cubrir gota o renovar superficies con relieve. De muy fácil lijado. Un solo producto para nivelar y terminar, dejando el soporte listo para pintar.	13,10
	CRISTAL EXTRAFINISH	15	40	Extrafina para preparar la superficies antes de pintar o para el acabado de tabiques y techos tratados con otros productos cuando se requieran acabados de gran calidad y finura.	13,92
	CRISTAL READY	20	33	Lista al uso indicada para realizar pequeñas renovaciones, alisar, reparar pequeñas irregularidades y en general para preparar soportes antes de pintar	25,60
Cola	AMBAR	20	64	Cola especial para el montaje de tabiques cerámicos de gran formato y pegado de otros materiales de construcción.	6,10



ARTICULOS		PVP* (€/ud)
710001	MALLA FIBRA DE VIDRIO 75 GR. DE 1X50 50M2 (YESO)	30.32
300620	MALLA ESPECIAL AISLANTE 160 GR DE 1X50 50M2	44.33



* IVA NO INCLUIDO

abr-24

OFICINA: C/CARACAS, N°10 (36203) VIGO – TFNOS. 986421617 / 986420560
 ALMACEN VINCIOS: RUA OUTEIRO DO FERRO – POLIG. A PASAXE – VINCIOS (GONDOMAR) – TFNO: 986467001
 ALMACEN PONTEAREAS: LOMBA, 81 – AREAS (PONTEAREAS) – TFNO: 986640283
 Mail: info@cabadacomercial.com / tecnicos@cabadacomercial.com / ponteareas@cabadacomercial.com
 Web: www.cabadacomercial.com



TARIFA DE PRECIOS

ARTICULOS	PVP* (€/UD)
PLANCHA LISA ESCAYOLA 100X60	1,84
BALDA ESTANTERIA 1200X300X40 MM	8,16
BALDA ESTANTERIA 1200X400X40 MM	10,78
BALDA ESTANTERIA 1200X500X40 MM	13,38

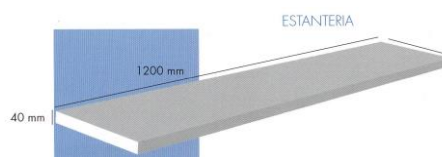

ARTICULOS	PVP* (€/UD)
M103-MOLDURA DE 65X45X1000	0,74
M104-MOLDURA DE 57X38X1000	0,74
M105-MOLDURA DE 60X40X1000	0,77
M201-MOLDURA DE 73X57X1000	0,95
M205-MOLDURA DE 80X50X1000	0,79
M206-MOLDURA ESCALONADA GRANDE 90X54X1200	1,38

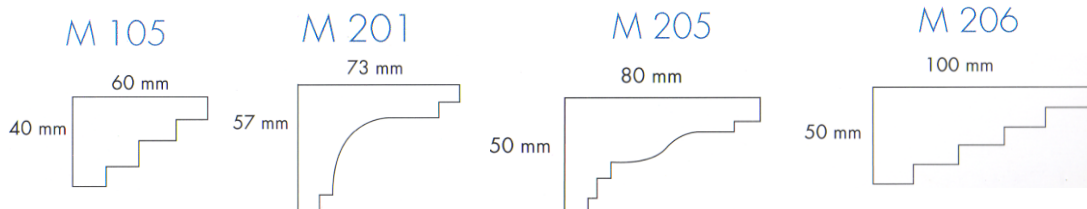
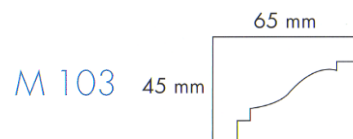

ARTICULOS	PVP* (€/M2)	
TECHO DESMONTABLE 600X600	DECOTECH (Capri, Sol, Fisurado)	4,09
	PERFORADO	13,92
	SEMIPERFORADO	5,88
	PERFORADO ACÚSTICO	13,92



ARTICULOS	PVP* (€/UD)
ESPARTO MEZCLA	10,95
ESPARTO MEZCLA ROLLO PEQUEÑO	4,95
ESPARTO SISAL BLANCO	14,95



PALET DE MADERA	12,00 €/UD
-----------------	------------

* IVA NO INCLUIDO

jun-23

OFICINA: C/CARACAS, Nº10 (36203) VIGO – TFNOS. 986421617 / 986420560
 ALMACEN VINCIOS: RUA OUTEIRO DO FERRO – POLIG. A PASAXE – VINCIOS (GONDOMAR) – TFNO: 986467001
 ALMACEN PONTEAREAS: LOMBA, 81 – AREAS (PONTEAREAS) – TFNO: 986640283
 Mail: info@cabadacomercial.com / tecnicos@cabadacomercial.com / ponteareas@cabadacomercial.com
 Web: www.cabadacomercial.com

TARIFA DE PRECIOS

ARTICULOS			PVP* (€/UD)
PAVIMENTOS – NIVELACIÓN DE SUELOS			
NIVELANTE 10 (gris)	25 KG	Pasta niveladora de fraguado rápido, reforzada con fibras	19.46
NIVELANTE 80 (gris claro)	25 KG	Para grandes recrecidos no estructurales	12.24
BETOLEVEL 15 (gris)	25 KG	De recrecido y excelente dureza	25.17
PAVIMENTOS - IMPRIMACIONES			
PROPAM GRIP +	5 KG	Imprimación promotora de adherencias universal, lista al uso	34.86
	15 KG		99.36
COLOCACIÓN DE CERÁMICA – ADHESIVOS INTERIORES –			
VAT GRIS	5 KG	Interior básico Cemento cola para fijación cerámica y gres	3.55
VAT BLANCO	5 KG		3.61
VAT GRIS	25 KG		3.87
VAT BLANCO	25 KG		4.50
COLOCACIÓN DE CERÁMICA – ADHESIVOS EXTERIORES –			
VAT SUPER GRIS	25 KG	Cemento cola para colocación de cerámica de absorción media en pavimentos y revest. int. y pav. ext.	5.86
VAT SUPER BLANCO	25 KG		6.37
VAT EXTRA GRIS	25 KG	Altas prestaciones	7.41
VAT EXTRA BLANCO	25 KG	Para Piscinas y Pladur	8.30
VAT PORCELÁNICO FLEXIBLE BLANCO	5 KG	Fijación gres porcelánico y piezas sin absorción	4.70
COLOCACIÓN DE CERÁMICA – ADHESIVOS ALTA FLEXIBILIDAD –			
VAT FLEX RAPID BLANCO	25 KG	Adhesivo deformable para colocación mármol y piedra natural , sin aparición de eflorescencias.	25.02
COLOCACIÓN DE CERÁMICA – ADHESIVOS SERIE ECOLÓGICA SIN POLVO –			
PAM ECOGEL PORCEL BLANCO	25 KG	Colocación de baldosas en paredes, suelos int y ext.	10.24
PAM ECOGEL PORCEL GRIS	25 KG		10.10
PAM ECOGEL FLEX BLANCO	25 KG	Flexible y deformable con elevado contenido en resinas	15.18
PAM ECOGEL FLEX GRIS	25 KG		14.35
COLOCACIÓN CERÁMICA – JUNTAS BASE CEMENTO–			
BORADA PORCELANICA CARTA COLORES	5 KG	Int y ext. hasta 4 mm	4.87
BORADA UNIVERSAL CARTA COLORES	5 KG	Int y ext. 1-15 mm	4.87
BORADA CHROMA BLANCO	3 KG	Inte y ex hasta 8 mm- EFECTO GOTA. Antimoho, flexible, especial gran formato.	5.36
BORADA CHROMA Antracita-negro-wengue-tundra-zafiro	3 KG		7.45
BORADA CHROMA COLORES	3 KG		6.67
COLOCACIÓN CERÁMICA – JUNTAS BASE EPOXI –			
BORADA EPOLUXE	3 KG	Mortero epoxi decorativo de fácil limpieza, para sellado antiácido de juntas hasta 20 mm	42.99
COLOCACIÓN CERÁMICA – JUNTAS RESINA			
BORALASTIC	2 LT	ADITIVO PARA BORADAS	14.95
REVESTIMIENTOS DE CAL – MORTEROS DE CAL			
REVAT CAL MURO – gris –	25 KG	Mortero de albañilería y recuperación de fábricas en base cal	7.98
REVAT CAL FONDO –gris –	25 KG	Mortero de revestimiento en base cal	8.06
REVAT CAL BASE – blanco o gris –	25 KG		12.88
REVAT CAL ENFOSCADO – colores –	25 KG	Mortero hidrófugo de revoco en base cal	9.21
REVAT CAL TRADICIONAL – colores –	25 KG	Mortero de cal para acabado tradicional	29.47
REVAT CAL ESTUCO – blanco –	25 KG	Estuco fino de cal - acabado fratasado	58.22
REVAT CAL FINO – blanco –	3 KG	Estuco fino de cal – acabados mate o brillante –	13.69
ADHESIVO PIEDRA			
ADHESIVO PIEDRA BLANCO	25 KG	Adhesivo específico para colocación de piedra y sus derivados	14,35



* IVA NO INCLUIDO

nov-23

OFICINA: C/CARACAS, N°10 (36203) VIGO – TFNOS. 986421617 / 986420560
 ALMACEN VINCIOS: RUA OUTEIRO DO FERRO – POLIG. A PASAXE – VINCIOS (GONDOMAR) – TFNO: 986467001
 ALMACEN PONTEAREAS: LOMBA, 81 – AREAS (PONTEAREAS) – TFNO: 986640283
 Mail: info@cabadacomercial.com / tecnicos@cabadacomercial.com / ponteareas@cabadacomercial.com
 Web: www.cabadacomercial.com

TARIFA DE PRECIOS



ARTICULOS			PVP* (€/UD)
REVESTIMIENTOS DE FACHADA – MORTERO MONOCAPA			
RE VAT PIEDRA	25 KG	CARTA COLORES	10.98
RE VAT PIEDRA	25 KG	VERDE	11.62
RE VAT RASPADO	25 KG	CARTA COLORES	11.36
REVESTIMIENTOS DE FACHADA – MORTERO REVOCO			
PROPAM REVOG GRIS	25 KG	Revest. Int y ext.. Aplicación Manual y máquina	3.85
PROPAM REVOG BLANCO	25 KG		4.37
PROPAM RENOVACIÓN	25 KG	Mortero hidráulico que actúa de recubrimiento para reparar fachadas	28.46
REVESTIMIENTOS DE FACHADA – CONSOLIDANTE			
PROPAM DUR	5 LT	Consolidante endurecedor	62.45
REVESTIMIENTOS DE FACHADA – HIDROFUGOS			
RE VAT PROTEC ORG / ACU	5 LT	Líquido hidro-repelente y protector de base orgánica (ORG) o base agua (ACU)	52.60
RE VAT PROTEC ORG / ACU	25 LT		194.92
REVESTIMIENTOS DE FACHADA – PRODUCTOS COMPLEMENTARIOS			
GRANITO PEQUEÑO	30 KG	COLORES	9.04
AISLAMIENTO TÉRMICO – MORTERO ADHESIVO Y DE PROTECCIÓN			
PROPAM AISTERM GRIS	25 KG	Mortero adhesivo hidrófugo. Colocación y protecc. placas poliestireno	16.38
PROPAM AISTERM BLANCO	25 KG		15.11
AISLAMIENTO TÉRMICO – MORTERO ACRÍLICO			
RE VAT PLAS - excepto UF,SLX.SLX UF-	20 KG	Mortero acrílico fachadas e int.	62.41
RE VAT FILM - excepto RUBI y ESP-	20 KG	Mortero sintético fachadas e int (imprimación)	64.28
MORTEROS DE ALBAÑILERIA			
MORTERO SILICEO M 7.5 BLANCO	25 KG	Colocación de ladrillo y bloque	4.57
REPARACIÓN Y PROTECCIÓN DEL HORMIGÓN - REPARACIÓN			
PROPAM REPAR TECHNO GRIS	5 KG	Mortero de fraguado rápido y retracción compensada para la reparación y enlucido del hormigón.	10.44
PROPAM REPAR TECHNO GRIS	25 KG		35.46
PROPAM REPAR 40 GRIS	25 KG	Mortero de reparación de estructuras de hormigón	24.44
PROPAM REPAR 20R	25 KG	Mortero de endurecimiento para pequeños anclajes y reparaciones no estructurales.	19.44
REPARACIÓN Y PROTECCIÓN DEL HORMIGÓN – PUENTE DE UNIÓN			
BETOPOX 93	2 KG	Puente unión epoxi de baja viscosidad para hormigones y morteros	43.11
SISTEMA DE IMPERMEABILIZACION - REVESTIMIENTOS CEMENTOSOS			
PROPAM IMPE GRIS	25 KG	Recubrimiento para impermeabilización de superficies	29.20
PROPAM IMPE BLANCO	25 KG		30.58
PROPAM IMPE BLANCO	5 KG		11.51
PROPAM IMPE FLEX GRIS	15 KG	Impermeabilización int y ext de hormigón y albañilería (sótanos, terrazas...)	61.56
SISTEMA DE IMPERMEABILIZACION - REVESTIMIENTOS ACRÍLICOS			
PROPAM IMPELASTIC	5 KG	Membrana líquida elástica y flexible, lista al uso, de secado rápido para la impermeabilización de superficies interiores y exteriores	40.74
	15 KG		114.19
MORTEROS TÉCNICOS - REJUNTADO			
PROPAM BLOCK (BLANCO Y GRIS)	25 KG	Mortero hidrófugo coloreado para encintado	4.48
PROPAM BLOCK (resto colores)	25 KG		6.69
MORTEROS TÉCNICOS - REFRACTARIO			
PROPAM REFRACTARIO GRIS	5 KG	Colocación ladrillo refractario. Int y ext.	10.99
	25 KG		21.35
MORTEROS TÉCNICOS – PRODUCTOS COMPLEMENTARIOS			
DESINCRUSTANTE DE CEMENTO	1 LT	.	4.60



ENTRA EN VIGOR EL 15 DE ENERO DE 2023

* IVA NO INCLUIDO

OFICINA: C/CARACAS, Nº10 (36203) VIGO – TFNOS. 986421617 / 986420560
 ALMACEN VINCOS: RUA OUTEIRO DO FERRO – POLIG. A PASAXE – VINCOS (GONDOMAR) – TFNO: 986467001
 ALMACEN PONTEAREAS: LOMBA, 81 – AREAS (PONTEAREAS) – TFNO: 986640283
 Mail: info@cabadacomercial.com / tecnicos@cabadacomercial.com / ponteareas@cabadacomercial.com
 Web: www.cabadacomercial.com

ene-23



TARIFA DE PRECIOS



CODIGO	DESCRIPCIÓN	PVP* (€/UD)
ARQUETA		
1372STAR	ARQUETA SIMPLE DE 200X200	3.65
1373STAR	ARQUETA SIMPLE DE 300X300	6.91
1374STAR	ARQUETA SIMPLE DE 400X400	15.84
1371STAR	ARQUETA SIMPLE DE 550X550	31.40
REJILLA ARQUETA DE PP REFORZADA		
1347	REJILLA ARQUETA DE 200X200	2.97
1357	REJILLA ARQUETA DE 300X300	7.55
1367	REJILLA ARQUETA DE 400X400	13.90
1377A	REJILLA ARQUETA DE 550X550	30.93
MARCO REFORZADO		
1395STAR	MARCO REFORZADO DE PP DE 200X200	1.57
1396STAR	MARCO REFORZADO DE PP DE 300X300	1.90
1397STAR	MARCO REFORZADO DE PP DE 400X400	3.79
1398STAR	MARCO REFORZADO DE PP DE 550X550	6.55
TAPADERA REFORZADA		
1348STAR	TAPADERA REFORZADA DE PP DE 200X200	2.14
1358STAR	TAPADERA REFORZADA DE PP DE 300X300	4.69
1368STAR	TAPADERA REFORZADA DE PP DE 400X400	11.13
1378STAR	TAPADERA REFORZADA DE PP DE 550X550	28.49

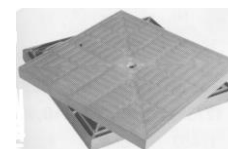
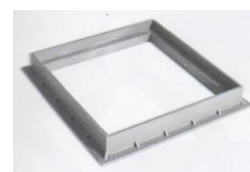
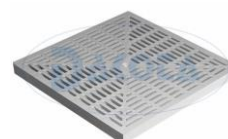

CODIGO	DESCRIPCIÓN	PVP* (€/UD)
TAPADERA REBAJADA		
POZ086857S	TAPADERA REBAJADA DE PP DE 300X300	7.28
POZ086858S	TAPADERA REBAJADA DE PP DE 400X400	12.42
PROLONGACIÓN		
POZ051376	PROLONGACIÓN ARQUETA H10 300X300	6,93
PLACA SIFÓNICA		
POZ061379	PLACA SIFÓNICA DE 300X300	2,33
POZ061380	PLACA SIFÓNICA DE 400X400	3.98



* IVA NO INCLUIDO

ene-24

OFICINA: C/CARACAS, Nº10 (36203) VIGO – TFNOS. 986421617 / 986420560
 ALMACEN VINCIOS: RUA OUTEIRO DO FERRO – POLIG. A PASAXE – VINCIOS (GONDOMAR) – TFNO: 986467001
 ALMACEN PONTEAREAS: LOMBA, 81 – AREAS (PONTEAREAS) – TFNO: 986640283
 Mail: info@cabadacomercial.com / tecnicos@cabadacomercial.com / ponteareas@cabadacomercial.com
 Web: www.cabadacomercial.com



TARIFA DE PRECIOS

CANALETA		
CODIGO	DESCRIPCIÓN	PVP* (€/UD)
POZ901310	CANALETA EN P.P. GRIS DE 100X13X7.5	7.49
1375CRA	KIT CANALETA 100X13X7.5 + REJILLA GALV CLIP 13X100	14.01
1300KC	KIT CANALETA 100X13X7.5 GRIS + REJILLA CLIP 13X100	12.51
1300KNC	KIT CANALETA 100X13X7.5 NEGRA + REJILLA CLIP 13X100	12.51
1395CRB	KIT CANALETA 100X13X9.5 + REJILLA GALV 13X100 + SYST.BLOCK	16.87
POZ901395TBB	CANALETA TAURUS 13 X 9.5 + REJILLA POLÍMERO B-125 (12,5 tn)	36.80
POZ901335P	CANALETA PEGASUS PLUS ONE 100X35X1000 + REJILLA GRIS	10.38
1351CL	REJILLA PARA CANALETA EN P.P. GRIS C/CLIP DE 100X13	8.65
1351GV	REJILLA PARA CANALETA ESTAMPADA GALVANIZADA 100X13	8.56
POZ901559PE	BLOCK SYSTEM PARA REJILLAS 13	2.55
1313	TAPON TERMINAL PLUS GRIS 13X7.5	1.15
1553PE	TAPON TERMINAL Ø75 13X9.5 "hasta fin existencias"	1.15
POZ901318	PERFIL REFUERZO INOXIDABLE 1.00 "hasta fin existencias"	16.12
ZIN061354I	BLOCK REFUERZO INOX PARA REJILLA "hasta fin existencias"	4.34
POZ901317	PERFIL GALVA REFUERZO CANALETA "hasta fin existencias"	6.58

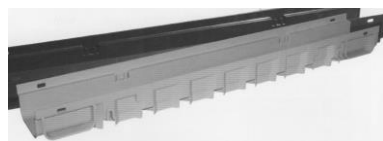

Block System

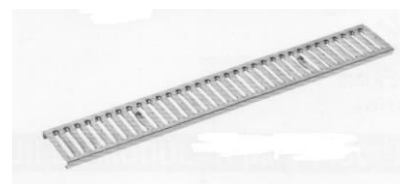

PRODUCTOS DESAGÜE		
ARTICULOS		PVP* (€/UD)
BOC011111	BOCA DESAGÜE REDONDA 100 H24	4.96
BOC021117	ANGULAR PARA DESAG DESAGÜE SALIDA 10	3,72



* IVA NO INCLUIDO

jun-23

OFICINA: C/CARACAS, Nº10 (36203) VIGO – TFNOS. 986421617 / 986420560
 ALMACEN VINCOS: RUA OUTEIRO DO FERRO – POLIG. A PASAXE – VINCOS (GONDOMAR) – TFNO: 986467001
 ALMACEN PONTEAREAS: LOMBA, 81 – AREAS (PONTEAREAS) – TFNO: 986640283
 Mail: info@cabadacomercial.com / tecnicos@cabadacomercial.com / ponteareas@cabadacomercial.com
 Web: www.cabadacomercial.com



TARIFA DE PRECIOS

Escaleras Escamoteables



ESCALERA ESCAMOTEABLE METÁLICA		
CODIGO	MEDIDAS (mm)	PVP* €/UD
SCA01-590/1	500X800X2800	376.59
SCA01-590/8	500X900X2800	
SCA01-590/2	500X1000X2800	
SCA01-590/80	600X800X2800	
SCA01-590/100	600X1000X2800	
SCA01-590/12	600X1200X2800	
SCA01-590/3	700X800X2800	
SCA01-590/4	700X900X2800	
SCA01-590/5	700X1000X2800	
SCA01-590/6	700X1100X2800	
SCA01-590/7	700X1200X2800	
PELDAÑO PARA ESCALERA		
DE 500 ANCHO 300 MM		69.75
DE 600 ANCHO 320 MM		
DE 700 ANCHO 400 MM		

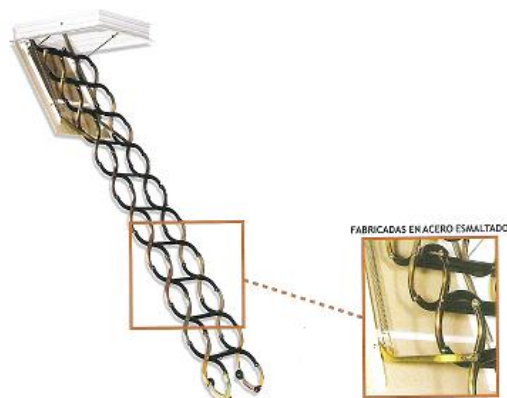

Oreficio Tamaño (d y s)	Ancho Paso (B)	Altura de Trabajo (A)	Altura de Trabajo (A)	Distancia Agujero base de la báscula (C)	Espacio apertura escala (R)
700 x 500	300	3200 - 2200	3200	1400	2100
800 x 500	300	3200 - 2200	3100	1300	2000
900 x 500	300	3200 - 2200	3000	1200	1850
1000 x 500	300	3200 - 2200	2900	1300	1800
800 x 600	320	3200 - 2200	2800	1450	1750
900 x 600	320	3200 - 2200	2700	1650	1700
1000 x 600	320	3200 - 2200	2600	1400	1650
1100 x 600	320	3200 - 2200	2500	1350	1600
1200 x 600	320	3200 - 2200	2400	1000	1650
700 x 700	400	3200 - 2200	2300	1250	1600
800 x 700	400	3200 - 2200	2200	1350	1550
900 x 700	400	3200 - 2200			
1000 x 700	400	3200 - 2200			
1100 x 700	400	3200 - 2200			
1200 x 700	400	3200 - 2200			

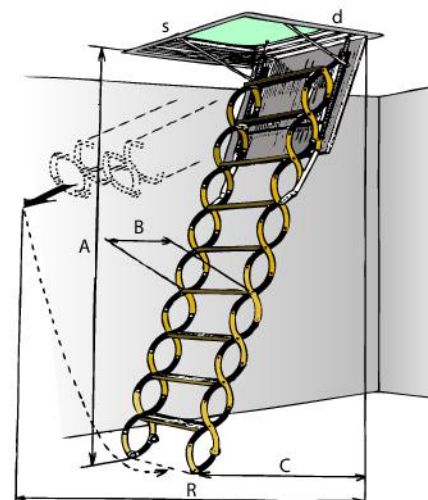

* IVA NO INCLUIDO

feb-23

OFICINA: C/CARACAS, N°10 (36203) VIGO – TFNOS. 986421617 / 986420560
 ALMACEN VINCIOS: RUA OUTEIRO DO FERRO – POLIG. A PASAXE – VINCIOS (GONDOMAR) – TFNO: 986467001
 ALMACEN PONTEAREAS: LOMBA, 81 – AREAS (PONTEAREAS) – TFNO: 986640283
 Mail: info@cabadacomercial.com / tecnicos@cabadacomercial.com / ponteareas@cabadacomercial.com
 Web: www.cabadacomercial.com



TARIFA DE PRECIOS

CONTRAMARCOS ENSAMBLADOS								PVP* (€/UD)
Anchura mm		Alto mm		Grosor mm				
Luz paso "P" +/-	Hueco máx."L"	Luz paso "A" Alto puerta	Hueco máx. "H" Alto estructura	Medida interior "S"	Grueso estructura "E"	Pared Acabada "T"	Espesor máx. Hoja	
ENLUCIDO								
600	1320	2030	2130	69	90	105	55	129,13
700	1520							129,13
800	1720							129,13
900	1920							137,40
1000	2120							177,18
CARTÓN YESO								
600	1320	2030	2130	50	70	100	35	129,13
700	1520							129,13
800	1720							129,13
900	1920							137,40
1000	2120							177,18

ACCESORIOS	
ARTÍCULO	PVP* (€/UD)
KIT UNION ENFOSCADO / CARTÓN YESO	21,45
AMORTIGUADOR (FRENO)	22,75
KIT CARRIL SUELTO	17,20
KIT APERTURA SIMULTÁNEA	61,95

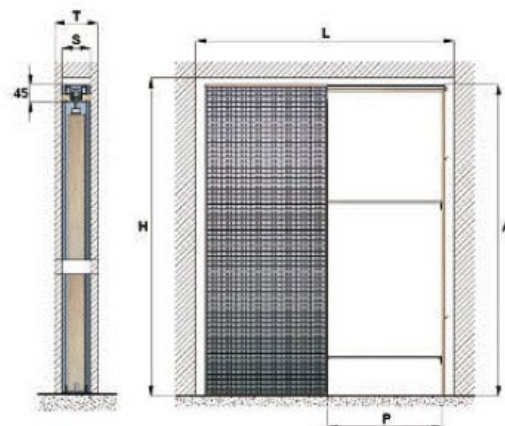

PUERTAS CORREDERAS EXTERNAS		
ARTÍCULO		PVP* (€/UD)
KIT PUERTA CORREDERA EXTERNA A PARED – Aluminio anodizado a pared	2 m	Consultar
	3 m	Consultar
KIT PUERTA CORREDERA EXTERNA A PARED – Madera blanco	2 m	Consultar
KIT PUERTA CORREDERA EXTERNA A PARED – Madera roble	2 m	Consultar
ACCESORIOS		
KIT PINZAS PARA PUERTA DE CRISTAL		Consultar
KIT DE UÑERO PARA PUERTA CORREDERA	Niquel satinado	Consultar
	Latonado pulido	Consultar
KIT CERRADURA CON CONDENA Y DESCONDENA	Niquel satinado	Consultar
	Latonado pulido	Consultar

* IVA NO INCLUIDO

oct-22

OFICINA: C/CARACAS, Nº10 (36203) VIGO – TFNOS. 986421617 / 986420560 FAX: 986483297
 ALMACEN VINCIOS: RUA OUTEIRO DO FERRO – POLIG. A PASAXE – VINCIOS (GONDOMAR) – TFNO: 986467001
 ALMACEN PONTEAREAS: LOMBA, 81 – AREAS (PONTEAREAS) – TFNO: 986640283
 Mail: info@cabadacomercial.com / tecnicos@cabadacomercial.com / ponteareas@cabadacomercial.com
 Web: www.cabadacomercial.com



TARIFA DE PRECIOS

ARTICULOS		APERTURA	MEDIDA	PASO LIBRE	PVP* (€/UD)
PUERTA CORTAFUEGO EI-60	1 HOJA	DERECHA IZQUIERDA REVERSIBLE	900X2050	810	197,76
PUERTA MULTIUSO (Sin homologar)	1 HOJA	DERECHA IZQUIERDA	900X2050	810	159,73

- Otros modelos : consultar precio y plazo de entrega



ACCESORIOS			
Consultar precio y plazo de entrega			
MIRILLA (Suelta o Montada)	EI-60	225 MM	PINTADA INOX
		300 MM	PINTADA INOX
	EI-90	225 MM	PINTADA INOX
		300 MM	PINTADA INOX
BARRA ANTIPÁNICO	PUERTA 1 HOJA	PREMONTADA	
	PUERTA 2 HOJAS	SUELTA PREMONTADA	
ELECTRO-IMÁN	PARED NORMAL		
	SUELO		
SELECTOR CIERRE			
SELECTOR CIERRE BÁSICO			
CUADRADILLO			
MEDIA PLACA NYLON – SOLO MANILLA			
BISAGRA SUELTA			
TENSOR BISAGRA			
MARCO TELESCÓPICO EN KIT 90			
BARRA ANTIPÁNICO PUERTA 1 HOJA SUELTA			82,40*
CERRADURA NORMAL			10,25*
MANILLA ESTÁNDAR			18,84*
CIERRA PUERTAS BÁSICO			41,41*

* IVA NO INCLUIDO

* MATERIALES BAJO PEDIDO CON CARGO DE TRANSPORTE ene-24



TARIFA DE PRECIOS

CÓDIGO	ARTICULO	PVP* (€/UD)
20MCA	ESQUINERO MONOCAPA DE 2500 (PVC)	1,77

* Para Revocos. Se utiliza para reforzar las esquinas



CÓDIGO	ARTICULO	PVP* (€/UD)
EP260	ESQUINERO PLÁSTICO DE 2.60 ML	0,84
EP300	ESQUINERO PLÁSTICO DE 3.00 ML	0,97

* Para Revestidos. Se utiliza para reforzar las esquinas



CÓDIGO	ARTICULO	PVP* (€/UD)
2027L	LISTELO CUADRADO BRILLO h.11x2600mm	8,80
2027S	LISTELO CUADRADO SATINADO h.11x2600mm	7,67

* Para azulejo. Se utiliza para proteger y decorar las esquinas en el azulejo.

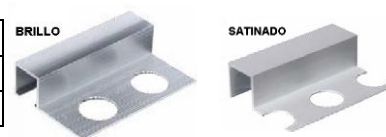

CÓDIGO	ARTICULO	PVP* (€/UD)
PRO202025L	LISTELO ALUMINIO EN T BRILLO h.11x2500mm	5,90
PRO202026L	LISTELO ALUMINIO EN T BRILLO h.20x2500mm	6,60

* Para azulejo y Terminal. Como acabado en suelos, para separar la unión de diferentes pavimentos (cerámica y parquet)



CÓDIGO	ARTICULO	PVP* (€/UD)
ZIN311662BE	GUARDAVIVO ALUMINIO 25X25X2500 mm	5.12

* Para protección o refuerzo de esquinas en la placa de **pladur** y para reformas habituales de interiores

CÓDIGO	ARTICULO	PVP* (€/UD)
JQ	JUNQUILLO MONOCAPA 2 M	1,40

ACCESORIOS AISLAMIENTO SISTEMA SATE

CÓDIGO	ARTICULO	PVP* (€/UD)
ZIN331660BOX	ANGULO VARIABLE C/RED 100X100X25000 mm	34,32

* Angulo con malla de fibra de vidrio. Para dar una resistencia uniforme en todo el aislamiento del edificio, cuando no está a 90°.

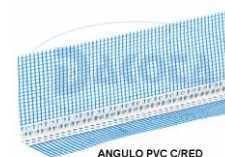

CÓDIGO	ARTICULO	PVP* (€/UD)
ZIN331669RV	ANGULO VIERTEAGUAS SUP. C/RED 100X100X2500mm	5,26
ZIN331669RVS	ANGULO VIERTEAGUAS ESP. C/RED 100X100X2500mm	

* Para protección de las esquinas. Ideal para dinteles de ventanas y cajones de persianas.



* IVA NO INCLUIDO

nov-23

TARIFA DE PRECIOS



CÓDIGO	ARTICULO	PVP* (€/UD)
333XA3	ADAPTADOR TOPE PROFUNDIDAD	12,66
333XA4	ADAPTADOR ROSCADOR VARILLA M6	13,76



CÓDIGO	ARTICULO	PVP* (€/UD)
SE105	AISLADOR ACUSTICO SE105	2,16
SE43	AISLADOR ACÚSTICO SE43	3,02
CN	CAZOLETA NIVELADORA (* fijación de un 2º falso techo)	0,33



CÓDIGO	ARTICULO	PVP* (€/UD)
664J10	ALCOTANA MANGO 300 MM	16,02



CÓDIGO	ARTICULO	PVP* (€/UD)
CM4	CARRIL MADERA LISO Nº 4	4,55
CM6	CARRIL MADERA LISO Nº 6	
900L15	CARRIL MEDIA CAÑA Nº 15	
900L16	CARRIL MEDIA CAÑA Nº 16	
900L20	CARRIL MADERA LISO Nº 20	6,10
900D20	CARRIL DENTADO Nº 20	



CÓDIGO	ARTICULO	PVP* (€/UD)
667P05	TIJERA PARA CHAPA 250 APERTURA RÁPIDA	13,30
664G02	SERRUCHO ESCAYOLISTA 16'' D.NORMAL	10,20
664G06	SIERRA CONTORNEAR 160MM	8,28
701014E	PUNZONADORA PERFILES 2 MANOS ECO	36,00



CÓDIGO	ARTICULO	PVP* (€/UD)
299069	BROCA SDS- PLUS 8X50 DE 110 MM	4,57
205304	BROCA SDS- PLUS 6X50 DE 110 MM	3,62
909500	BROCA SDS- PLUS 5X50 DE 110 MM	3,46

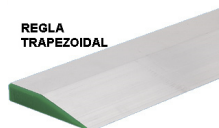
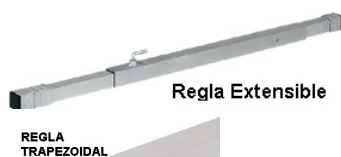

CÓDIGO	ARTICULO	PVP* (€/UD)
304AM2	REGLA EXT ALU MUELLE 180-300	35,14
304AM3	REGLA EXT ALU MUELLE 230-400	40,51
304M02	REGLA EXT GALV MUELLE 180-300	30,03
305T15	REGLA ALU TRAPEZOIDAL 1500MM	16,95
305T20	REGLA ALU TRAPEZOIDAL 2000MM	22,30
305HC2	REGLA H CERRADA ALUMINIO DE 1,50	17,65
R200	REGLA H CERRADA ALUMINIO DE 2.00	23,57
R250	REGLA H CERRADA ALUMINIO DE 2.50	29,44
305TT1	REGLA YESERO ALU DOBLE T 1200MM	12,61

* IVA NO INCLUIDO

ene-23

TARIFA DE PRECIOS



Guión yesero

CÓDIGO	ARTICULO	PVP* (€/UD)
C8	CEPILLO 8 CUCHILLAS (GUION YESERO)	16,70



Escofina para placas y recambio

CÓDIGO	ARTICULO	PVP* (€/UD)
701022	ESCOFINA PLACAS TIPO ESCARABAJO	8,15
701005	REPUESTO ESCOFINA DE PLACAS 250MM	5,60



RASPILLA/CUCHILLA

CÓDIGO	ARTICULO	PVP* (€/UD)
605I01	RASPILLA (CUCHILLA) INOX 140X70	1,61
605IR1	RASPILLA (CUCHILLA) INOX 140X70(1C.RED)	1,83
605I02	RASPILLA (CUCHILLA) LISA INOX 120X60	1,26
605IR2	RASPILLA (CUCHILLA) LISO INOX 120X60(1 C. RED)	1,45



Espátula Inox. Flexible

CÓDIGO	ARTICULO	PVP* (€/UD)
904S10	ESPATULA INOX FLEX M. GOMA 100 MM	6,51
904S12	ESPATULA INOX FLEX M. GOMA 125 MM	7,80
904S15	ESPATULA INOX FLEX M. GOMA 150 MM	8,37
661003	ESPATULA M.MADERA FLEXIBLE ESCAY	8,58



Espátula M.Madera Flexible

CÓDIGO	ARTICULO	PVP* (€/UD)
LLP	LLANA PLÁSTICO GRIS M. Plástico 520X120	9,60
662TPA	LLANA PLÁSTICO ABS 300X140 M. AM	6,05
663CV1	LLANA INOX 300X120 CURVA M.AME	16,75
663IA3	LLANA INOX 300X140 AFILADA SOLD. M.NORMAL	11,30
66TRIO	LLANA INOX 500X130 AFILADA M. ROJO	19,80
662TPB	LLANA POLIESTIRENO 280X140MM	4,30
663RB2	RASCADOR MONOCAPA 250X144 M.NORMAL	6,80
566512	TALOCHA LIMP. ESPONJA 280X140	3,63
566513	TALOCHA ESPONJA CORTADA 30MM	4,45



TALOCHA LIMP. ESPONJA



Talocha Esponja cortada



LLANA INOX CURVA 300X120



Llana Inox Afilada



LLANA PARA JUNTAS



LLANA PLÁSTICA



Llana Plástica ABS

CÓDIGO	ARTICULO	PVP* (€/UD)
904RG2	PALETA ESTR INOX 120 MM M.ERGONOMICO	4,65
904RG6	PALETA ESTR INOX 200 MM M.ERGONOMICO	6,80
904U11	PALETIN ANGULO INT INOX 120X100	14,40
904U02	PALETÍN ANGULO EXT INOX 120X100	

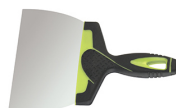

PALETA ESTR. INOX



Paletín Angulo Inox

* IVA NO INCLUIDO

ene-23



TARIFA DE PRECIOS

FIJACIÓN RÁPIDA
OMEGA DOBLE ROSCA

CÓDIGO	ARTICULO	PVP* (€/UD)
921014	FIJACIÓN RÁPIDA OMEGA M6 D.ROSC	0,25

REMACHE
FLOR

CÓDIGO	ARTICULO	PVP* (€/UD)
914F00	REMACHE FLOR Ø 4.8X35	0,07



Taco Paraguas

CÓDIGO	ARTICULO	PVP* (€/UD)
903T28	TACO PARAGUAS 10X38 MM	0,09



TACO LATÓN

CÓDIGO	ARTICULO	PVP*
090434	TACO LATON Nº 4 (200 UD)	8,00 €/CAJA
903S09	TACO LATON Nº 6 (100 UD)	10,25 €/CAJA



TACO NYLON

CÓDIGO	ARTICULO	PVP*
903T04	TACO NYLON MULTIUSO 6X30 (200 UD)	5,50 €/CAJA



Taco rápido c/collarín

CÓDIGO	ARTICULO	PVP*
903TC0	TACO RAPIDO CON COLLARIN 6X37 – 200 UD	8,30 €/CAJA



CÓDIGO	ARTICULO	PVP* (€/UD)
03174	TUERCA HEXAGONAL M4	0,02
903S07	TUERCA HEXAGONAL M6 (200 UD)	3,00 €/CAJA



Varilla Roscada



CÓDIGO	ARTICULO	PVP* (€/UD)
09584	VARILLA ROSCADA Ø 4	0,40
186003	VARILLA ROSCADA Ø 6	0,60
ARH	ARANDELA HIERRO DE 30 MM	0,08



MANGUITO HEX.

CÓDIGO	ARTICULO	PVP* (€/UD)
903S05	MANGUITO M-6X20 HEXAGONAL	0,20

GRAPA VIGUETA PARA
VARILLA

CÓDIGO	ARTICULO	PVP* (€/UD)
921022	GRAPA VIGUETA PARA VARILLA M6 1.5-4MM	0,70
921002	GRAPA VIGUETA PARA VARILLA M6 4-10MM	



ALISADOR ESPONJA

CÓDIGO	ARTICULO	PVP* (€/UD)
560507	ALISADOR ESPONJA 280X140	6,67

* IVA NO INCLUIDO

ene-24



TARIFA DE PRECIOS

ARTICULO				PVP* (€/UD)
OCN	ESPUMA MULTIUSOS ORBAFOAM **NUEVOS FORMATOS**	CÁNULA (670ml)	Espuma de poliuretano de uso general para aplicación con cánula manual o pistola. Para aislar en la instalación de puertas y ventanas, para el relleno y sellado de todo tipo de huecos y pasantes en construcción en general.	4,21 €
OPN		PISTOLA (700 ml)	Alta adherencia a todos los materiales construcción. Alto aislamiento térmico y acústico.	4,36 €
OF60	ORBAFOAM FIJACION 60 SEG		Adhesivo para la fijación en espuma de agarre inmediato. Ideal para la fijación de todo tipo de paneles aislantes, planchas eps/xps, paneles de yeso, madera, conglomerados, elementos decorativos, reparaciones...	10,31 €
PU50	SINTEX PU-50 300 ML BLANCO, GRIS, MARRÓN Y NEGRO		Sellador-Adhesivo de poliuretano de módulo medio- alto para el pegado y sellado elástico. Fuerte y elástico 2 en 1. Interior y exterior. Pintable. Excelente adhesión en cemento, ladrillo, cerámica, metales, madera, poliuretano, epoxi y algunos poliésteres.	3,60 €
MS35	SINTEX MS-35 300 ML GRIS, NEGRO Y BLANCO		Sellador-adhesivo de polímero MS para el pegado y sellado elástico. Adhiere en húmedo. Alta resistencia y elasticidad. Alta resistencia a la intemperie y rayos UV. Excelente adherencia sobre madera, metales, vidrio, cerámica, mortero, piedra, PVC. Pintable. Libre de isocianatos y disolventes. Juntas de suelo transitables. Sellado de carpintería a obra y carpintería entre sí. Sellado de cubiertas metálicas.	5,05 €
OPR	ORBAFOAM TEJAS PARA PISTOLA ROJO TEJA		Espuma adhesiva de poliuretano para pegar y colocar tejas. Aplicación con cánula manual o pistola. Para el pegado de todo tipo de tejas a superficies de hormigón, mortero, madera o fibrocemento. Adherencia fuerte y duradera a la mayoría de los materiales de construcción. Baja expansión.	5,65 €*
OPR650	ORBAFOAM TEJAS PARA PISTOLA ROJO TEJA 650 ML			5,25 €
OCR	ORBAFOAM TEJAS PARA CÁNULA ROJO TEJA			5,56 €*
OCR650	ORBAFOAM TEJAS PARA CÁNULA ROJO TEJA 650 ML			5,15 €
PEC	PISTOLA ESPUMA CALIBER 30		Pistola para la aplicación de espuma de poliuretano	11,95 €
OL	ORBAFOAM LIMPIADOR ESPUMA 500 ML		Para limpiar y eliminar residuos de espuma de poliuretano ya curada.	6,35 €
MST	SINTEX MS TRANSPARENTE 280 ML		Sellador- adhesivo de polímero M para el pegado y sellado elástico. Adhiere en húmedo. Alta resistencia y elasticidad. Alta resistencia a la intemperie y rayos UV. Excelente adherencia sobre madera, metales, vidrio, cerámica, mortero, piedra, PVC. Pintable. Libre de isocianatos y disolventes. Juntas de suelo transitables. Sellado de carpintería a obra y carpintería entre sí. Sellado de cubiertas metálicas.	5,27 €

*Hasta final de existencias



* IVA NO INCLUIDO

ene-24

OFICINA: C/CARACAS, Nº10 (36203) VIGO – TFNOS. 986421617 / 986420560
 ALMACEN VINCIOS: RUA OUTEIRO DO FERRO – POLIG. A PASAXE – VINCIOS (GONDOMAR) – TFNO: 986467001
 ALMACEN PONTEAREAS: LOMBA, 81 – AREAS (PONTEAREAS) – TFNO: 986640283
 Mail: info@cabadacomercial.com / tecnicos@cabadacomercial.com / ponteareas@cabadacomercial.com
 Web: www.cabadacomercial.com

ANEXO – I –



TARIFA DE PRECIOS

ARIDOS / MORTEROS

	ARTICULOS	PVP* (€/ud)
CGC	CEMENTO CARRAL II/B-L 42.5R 25KG	4,40
A	ARENA ENTREFINA 0/4 SACO ± 900K	30,00
AF	ARENA FINA 0/2 SACO ± 1000 KG	30,00
SG	SACO GRAVA 10/20	30,00
MM75	MORTERO MAMPOSTERÍA M 7.5 GRIS 25 KG	2,75
HORSEC25	HORMIGÓN SECO 25 KG	4,18



	ARTICULOS	PVP* (€/ud)
CA	CAPAZO DE ARENA 55/60 KG	2,50
PC	PALET CEMENTO Y MORTERO (se abonará por el mismo importe a su devolución)	15,00
9900001	SACA BIG BAG	4,05

* IVA NO INCLUIDO

ene-24

OFICINA: C/CARACAS, N°10 (36203) VIGO – TFNOS. 986421617 / 986420560
ALMACEN VINCOS: RUA OUTEIRO DO FERRO – POLIG. A PASAXE – VINCOS (GONDOMAR) – TFNO: 986467001
ALMACEN PONTEAREAS: LOMBA, 81 – AREAS (PONTEAREAS) – TFNO: 986640283
Mail: info@cabadacomercial.com / tecnicos@cabadacomercial.com / ponteareas@cabadacomercial.com
Web: www.cabadacomercial.com

ANEXO – II –



TARIFA DE PRECIOS

ARTICULO	PALET	PVP* €
PIEDRA MUSGO FINA 8 / 9 CM	±10 FILAS	120,00



HASTA FIN DE EXISTENCIAS:

ARTICULO	PALET	PVP* €
CUARCITA AMARILLA (OXIDO)	±15 FILAS (±14 M2)	130,00
	±30 FILAS (±28 M2)	250,00

TACO PIEDRA MUSGO (espesor variado)	7/8 M2	156,20
-------------------------------------	--------	--------

* IVA NO INCLUIDO

oct-22

OFICINA: C/CARACAS, Nº10 (36203) VIGO – TFNOS. 986421617 / 986420560 FAX: 986483297
ALMACEN VINCOS: RUA OUTEIRO DO FERRO – POLIG. A PASAXE – VINCOS (GONDOMAR) – TFNO: 986467001
ALMACEN PONTEAREAS: LOMBA, 81 – AREAS (PONTEAREAS) – TFNO: 986640283
Mail: info@cabadacomercial.com / tecnicos@cabadacomercial.com / ponteareas@cabadacomercial.com
Web: www.cabadacomercial.com

-ANEXO IV-