



Cabada

EXCLUSIVAS PARA LA CONSTRUCCIÓN

TARIFA 2025

1 - ABRIL



OFICINA: C/CARACAS, Nº10 (36203) VIGO – TFNOS. 986421617 / 986420560

ALMACEN VINCIOS: RUA OUTEIRO DO FERRO – POLIG. A PASAXE – VINCIOS (GONDOMAR) – TFNO: 986467001

ALMACEN PONTEAREAS: LOMBA, 81 – AREAS (PONTEAREAS) – TFNO: 986640283

Mail: info@cabadacomercial.com / tecnicos@cabadacomercial.com / ponteareas@cabadacomercial.com

Web: www.cabadacomercial.com

PLADUR[®]

VELUX[®]
La ventana para tejados

Euronit[®]

ALGISS[®]

Tejas
Verea
Desde 1962

Riwega[®]

Onduline[®]

UMBELINO MONTEIRO
COBERTURAS PARA A VIDA

CERANOR

ChovA
IMPERMEABILIZACIÓN Y AISLAMIENTO

BMI

polynum

Molins[®]

ARLITA Leca[®]

URSA

HORMADISA

Quilosa[®]
PROFESSIONAL

ESYEDEBRO

THU

DAKOZA

PRU

kriket

ASTURMADI
DOORS

mora
CERÁMICAS



INDICE

➤ PRODUCTOS CERÁMICOS Y PIEDRA	Pág. 3 – 10
TEJA MIXTA BMI	Pág. 3
TEJA PLANA BMI.....	Pág. 4
TEJA UMBELINO MONTEIRO	Pág. 5
TEJA VEREA	Pág. 6
LADRILLO CARA VISTA – CERANOR	Pág. 8
LADRILLOS	Pág. 9
TERMOBRICK.....	Pág. 10
➤ CUBIERTAS	Pág. 11 – 21
PLACA FIBROCEMENTO (Gran onda, Minionda, Mixta).....	Pág. 11
ONDULINE BT	Pág. 12
ONDUCOBER, ONDUVILLA Y ACCESORIOS	Pág. 13
ACCESORIOS ONDULINE	Pág. 14
PANEL SANDWICH ONDUTHERM (A CONSULTAR)	Pág. 15
PLÁSTICOS – ONDULINE -	Pág. 16-17
ACCESORIOS CUBIERTAS.....	Pág. 18-20
PANEL CUBIERTA.....	Pág. 21
➤ FORJADOS	Pág. 22 – 28
FORJADO SANITARIO FERRACÍN	Pág. 22
TUBOS ENCOFRADO, MALLA ELECTROSOLDADA, FIBRA PP	Pág. 23
VIGUETAS ARMADAS (A CONSULTAR)	Pág. 24-25
BOVEDILLAS (Hormigón, arlita, poliestireno y cerámica)	Pág. 26
ACCESORIOS FORJADOS – Separadores y seguridad –	Pág. 27
VIGUETAS PRETENSADAS, DINTELES Y POSTES RECTOS	Pág. 28
➤ PREFABRICADOS DE HORMIGÓN	Pág. 29 – 33
POSTES.....	Pág. 29
AROS Y TAPAS DE POZO, TAPAS DE NICHOS	Pág. 30
BLOQUE CIERRE, BLOQUE MURO, BORDILLO DE JARDÍN Y ARQUETAS DE CEMENTO.....	Pág. 31
FOSAS SÉPTICAS (A CONSULTAR)	Pág. 32-33
➤ AISLAMIENTOS	Pág. 34 – 38
POLIESTIRENO EXTRUIDO – CHOVAFOAM –.....	Pág. 34
LANA MINERAL – URSA – , LANA DE ROCA – ROCKWOOL –	Pág. 35
AISL. REFLECTIVO – POLYNUM - ARLITA Y PERLITA.....	Pág. 36
POLIESTIRENO EXPANDIDO.....	Pág. 37
ACCESORIOS AISLAMIENTO	Pág. 38
➤ IMPERMEABILIZACIÓN Y AISLAM. – ASFALTOS CHOVA –	Pág. 39 – 43
POLITABER, CHOVAPLAST, RAPID-BRIC Y CHOVIPOL	Pág. 39
TEGOLA, IMPRIMACIONES Y EMULSIONES, SLURRYS, Y ACCESORIOS.....	Pág. 40
CHOVATEC ANTIGOTERAS, MALLA, LAMINA DRENANTE, GEOFIM CHOVATERM (lámina con poliest. Extruido).....	Pág. 41
CHOVASTAR	Pág. 42
AISLAMIENTO ACÚSTICO RUIDO AÉREO, RUIDO DE IMPACTO	Pág. 43
➤ YESOS, ESCAYOLAS Y CEMENTO	Pág. 44
YESOS Y ESCAYOLAS – ESYEDEBRO Y ALGISS–, MALLA YESO Y MALLA REVEST EXTERIOR	
➤ PRODUCTOS DE ESCAYOLA	Pág. 45
PLANCHA LISA, BALDAS, MOLDURAS, TECHO DESMONTABLE ESPARTO (Mezcla y Sisal)	



INDICE

➤ CEMENTOS COLA Y MORTEROS PROPAMSA	Pág. 46 – 47
NIVELANTES, ADHESIVOS, JUNTAS, REVAT CAL	Pág. 46
MORTEROS FACHADA E INTERIORES, AISTERM, REPARACIÓN HORMIGÓN, ANCLAJES Y MONTAJES, IMPERMEABILIZACIÓN E IMPRIMACIÓN	Pág. 47
➤ PRODUCTOS DRENAJE Y DESAGÜE	Pág. 48 – 49
ARQUETA, REJILLA REFORZADA, MARCO REFORZADO, TAPADERA REFORZADA, TAPADERA REBAJADA, PROLONGACIÓN Y PLACA SIFÓNICA	Pág. 48
CANALETAS	Pág. 49
BOCA DESAGÜE, ANGULAR DESAGÜE	Pág. 49
➤ ESCALERA ESCAMOTEABLE Y CONTRAMARCOS	Pág. 50 - 51
ESCALERA ESCAMOTEABLE METÁLICA	Pág. 50
CONTRAMARCOS KRIKET	Pág. 51
➤ PUERTAS	Pág. 52
PUERTAS CORTAFUEGO Y ACCESORIOS PUERTAS MULTIUSO	
➤ LISTELOS Y PERFILES	Pág. 53
ESQUINERO PLÁSTICOS, ESQUINERO MONOCAPA LISTELO CUADRADO, LISTELO ALUMINO EN T GUARDAVIVO ALUMINIO ANGULO PVC, ANGULO VIERTEAGUAS	
➤ ACCESORIOS Y HERRAMIENTAS	Pág. 54 – 56
ADAPTADOR TOPE PROFUNDIDAD	Pág. 54
AISLADOR ACÚSTICO	Pág. 54
CAZOLETA NIVELADORA	Pág. 54
ALCOTANA	Pág. 54
CARRIL MADERA, MEDIA CAÑA Y DENTADO	Pág. 54
TIJERA PARA CHAPA, SERRUCHO Y SIERRA CONTORNEAR	Pág. 54
PUNTAS ACERO	Pág. 54
BROCAS SDS-PLUS	Pág. 54
REGLAS	Pág. 54
CEPILLO 8 CUCHILLAS	Pág. 55
ESCOFINA PLACAS Y REPUESTO	Pág. 55
RASPILLAS (CUCHILLAS)	Pág. 55
ESPATULAS	Pág. 55
LLANAS	Pág. 55
PALETA	Pág. 55
FIJACIÓN RÁPIDA OMEGA	Pág. 56
REMACHE FLOR	Pág. 56
TACO PARAGÜAS	Pág. 56
TACO LATÓN	Pág. 56
TACO NYLÓN	Pág. 56
TACO RÁPIDO CON COLLARÍN	Pág. 56
TUERCA HEXAGONAL	Pág. 56
VARILLA ROSCADA	Pág. 56
ARANDELA DE HIERRO	Pág. 56
GRAPA VIGUETA PARA VARILLA	Pág. 56
CRUCETAS Y NIVELANTES	Pág. 57
➤ ESPUMAS QUILOSA	ANEXO – I –
➤ ÁRIDOS Y MORTERO MAMPOSTERÍA	ANEXO – II –
➤ PIEDRA MONTE	ANEXO – III –



TARIFA DE PRECIOS

ARTICULOS			PVP* (€/UD)
TEJA MIXTA S10			
ROJA	458X282 3.800 kg PALET: 240 uds/palet 10,5 ud/m2 Rastrel: 40,1-40,3 cm		1,56
TEJA MIXTA DUNA			
ROJA	454x288 3.900 kg PALET: 216 uds/palet 10,5 ud/m2 Rastrel: 39,3-40,1 cm		1,70
MARRÓN			2,08
PIEZAS ESPECIALES			
CABALLETE UNIVERSAL	COLORES	2,5 UD/ML	7,25
CABALLETE 3 VÍAS	COLORES		34,10
FINAL LIMATESA	COLORES		18,60
TAPA DE CABALLETE	COLORES		36,00
CUÑA	COLORES	4,5 UD/ML	2,80
REMATE LATERAL UNIVERSAL	COLORES	2,4 UD/ML	7,05
REMATE LATERAL DCHO/IZQ	COLORES	2,5 UD/ML	7,15
TEJA SOPORTE CHIMENEA	COLORES		55,20
CHIMENEA	COLORES		58,95
MEDIA TEJA	COLORES		5,10
TEJA VENTILADORA + REJILLA	COLORES	0,1 UD/m2	19,25

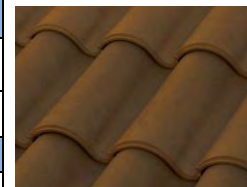
DUNA
MARRÓN

ARTICULOS			PVP* (€/UD)
TEJA MIXTA MERIDIONAL (KLINKER)			
ROJA	424X258 3.150 kg PALET: 320 uds/palet 12,5 ud/m2 Rastrel: aprox 36,5		1,86
MAGMA			2,08
ÉBANO			2,26
PIEZAS ESPECIALES			
CABALLETE UNIVERSAL	COLORES	2,5 UD/ML	9,15
CABALLETE 3 VÍAS	COLORES		70,30
FINAL LIMATESA	COLORES		36,25
TAPA DE CABALLETE	COLORES		35,45
CUÑA	COLORES	4,5 UD/ML	3,80
REMATE LATERAL UNIVERSAL	COLORES	2,4 UD/ML	9,60
REMATE LATERAL DCHO/IZQ	COLORES	2,5 UD/ML	9,25
TEJA SOPORTE CHIMENEA	COLORES		64,35
CHIMENEA	COLORES		66,10
MEDIA TEJA	COLORES		5,60
TEJA VENTILADORA + REJILLA	COLORES	0,1 UD/m2	32,60



ROJO



ÉBANO



* IVA NO INCLUIDO

abr-24



TARIFA DE PRECIOS



ARTICULOS			PVP* (€/UD)
TEJA MARSELLA COLLADO			
ROJA	432x262 3.300 kg PALET: 210 uds/palet 12-13,5 ud/m2 Rastrel: 33-37 cm		1,82
PIEZAS ESPECIALES			
CABALLETE CLÁSICO	COLORES	240 uds/palet	7,25
FINAL LIMATESA	COLORES		18,60
TAPÓN CABALLETE	COLORES		35,45
REMATE LATERAL UNIVERSAL	COLORES	284 uds/palet	7,05
TEJA DE VENTILACIÓN + REJILLA	COLORES		20,20
TEJA SOPORTE CHIMENEA	COLORES		53,55
CHIMENEA	COLORES		58,95
TEJA PLANA LISA – LÓGICA PLANA			
COLORES (ébano, galena y marrón)	Colores: 454x283 4.550 kg PALET: 210 uds/palet 11 ud/m2 Rastrel(máximo): Roja 37,5 cm Colores: 37cm		2,97
PIEZAS ESPECIALES			
MEDIA TEJA PLANA	COLORES	210 uds/palet	5,80
CABALLETE UNIVERSAL	COLORES	192 uds/palet	9,15
CABALLETE PLANO	COLORES	144 uds/palet	11,05
TAPON CABALLETE UNIVERSAL	COLORES	284 uds/palet	37,30
TAPÓN CABALLETE PLANO	COLORES		
REMATE LATERAL UNIVERSAL	COLORES	284 uds/palet	9,60
REMATE LATERAL DCHO/IZQ	COLORES	64 uds/palet	7,85
TEJA VENTILADORA + REJILLA	COLORES		31,85
TEJA SOPORTE CHIMENEA	COLORES		64,35
TAPA SALIDA DE HUMOS	COLORES		16,20



MARSELLA

LÓGICA
PLANA

* IVA NO INCLUIDO

feb-24

OFICINA: C/CARACAS, Nº10 (36203) VIGO – TFNOS. 986421617 / 986420560 FAX: 986483297
 ALMACEN VINCIOS: RUA OUTEIRO DO FERRO – POLIG. A PASAXE – VINCIOS (GONDOMAR) – TFNO: 986467001
 ALMACEN PONTEAREAS: LOMBA, 81 – AREAS (PONTEAREAS) – TFNO: 986640283
 Mail: info@cabadacomercial.com / tecnicos@cabadacomercial.com / ponteareas@cabadacomercial.com
 Web: www.cabadacomercial.com

TARIFA DE PRECIOS

ARTICULOS			PVP* (€/UD)
TEJA MIXTA ADVANCE PREMIUM			
TEJA 	ROJO	445X249 mm	1,35
	CASTAÑA / ECLIPSE	13 ud/m ²	2,20
	COLORES	Rastrel 38 cm 288 ud/palet	1,78
CUMIO	ROJO	2.5 ud/ml	2,82
	COLORES		4,56
CUÑA	ROJO	10 ud/ml	0,83
	COLORES		1,29
MEDIA TEJA	ROJO		3,42
	COLORES		4,78
REMATE LATERAL	ROJO	2.5 ud/ml	6,72
	COLORES		11,08
CUMIO TRES VÍAS (3H MACHO / HEMBRA)	ROJO		15,75
	COLORES		25,49
INICIO CABALLETE	ROJO		11,83
	COLORES		19,34
TEJA VENTILADORA + REJILLA	ROJO		9,68
	COLORES		14,53
TAPÓN CUMBRERA (FRONTÓN)	ROJO		14,56
	COLORES		18,33
TEJA TRANSITO	ROJO		17,66
TEJA SOPORTE CHIMENEA	ROJO		41,55
CHIMENEA (cónica / cilíndrica)	ROJO		54,15

TEJA MARSELLA ADVANCE PREMIUM			
TEJA 	ROJO	445 x 245 mm	1,35
	ROJA ENVEJECIDA	13 ud/m ²	1,78
	ECLIPSE	Rastrel 38 cm 320 ud/palet	2,20
CUMIO	ROJO	2.5 ud/ml	2,82
	COLORES		4,56
REMATE LATERAL	ROJO	2.5 ud/ml	6,72
	COLORES		11,08
CUMIO TRES VÍAS (3H MACHO / HEMBRA)	ROJO		15,75
	COLORES		25,49
INICIO CABALLETE	ROJO		11,83
	COLORES		19,34
MEDIA TEJA	ROJO		3,97
	COLORES		7,22
TEJA VENTILADORA Y TRÁNSITO	ROJO		18,41
	COLORES		24,18

TEJA CURVA			
TEJA 	ROJO	445X158	0,70
	COLORES	30 ud/m ² 630 ud/palet	0,96
CUMIO	ROJO	2.8 ud/ml	2,48
	COLORES		4,58
CUÑA	ROJO	10 ud/ml	0,70
	COLORES		1,25
TEJA VENTILADORA	ROJO		8,00
	COLORES		14,76
TEJA DE TRANSITO	ROJO		13,65

* TEJA VIDRIADA A CONSULTAR *

* IVA NO INCLUIDO

oct-22

OFICINA: C/CARACAS, N°10 (36203) VIGO – TFNOS. 986421617 / 986420560
 ALMACEN VINCIOS: RUA OUTEIRO DO FERRO – POLIG. A PASAXE – VINCIOS (GONDOMAR) – TFNO: 986467001
 ALMACEN PONTEAREAS: LOMBA, 81 – AREAS (PONTEAREAS) – TFNO: 986640283
 Mail: info@cabadacomercial.com / tecnicos@cabadacomercial.com / ponteareas@cabadacomercial.com
 Web: www.cabadacomercial.com



TARIFA DE PRECIOS

ARTICULO	ROJA	MARRÓN	ENVEJECIDA	JACOBEA	GRAFITO
TEJA CURVA	PVP €/ud	PVP €/ud	PVP €/ud	PVP €/ud	PVP €/ud
TEJA 40X15 (Soporte placa 177, 34 ud/m2, 624 ud/palet)	0,48	0,57	0,59	0,66	0,66
TEJA 40X20 (Soporte placa 230/BT235, 26 ud/m2, 384 ud/palet)	0,68	-	-	-	-
CUMIO 50X21	1,07	1,20	1,16	1,23	1,26
TEJA ALERO 40X15	0,58	0,67	0,69	0,76	0,75
REMATE LATERAL RECTO DCHO/IZQ	4,46	5,85	5,85	5,85	5,85
CUÑA PEQUEÑA	1,53	2,03	2,03	2,03	2,03
TAPÓN CUMBRERA	18,90	28,97	28,97	28,97	28,97
VENTILADORA	9,07	12,09	12,09	12,09	12,09

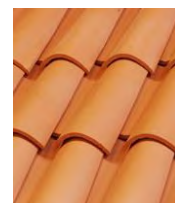

PALETS (se abonarán a su devolución)	4,00 €/UD
---	------------------



NOTA: CONSULTAR ACCESORIOS PARA CUBIERTA

* IVA NO INCLUIDO

mar-25

OFICINA: C/CARACAS, Nº10 (36203) VIGO – TFNOS. 986421617 / 986420560 FAX: 986483297
 ALMACEN VINCOS: RUA OUTEIRO DO FERRO – POLIG. A PASAXE – VINCOS (GONDOMAR) – TFNO: 986467001
 ALMACEN PONTEAREAS: LOMBA, 81 – AREAS (PONTEAREAS) – TFNO: 986640283
 Mail: info@cabadacomercial.com / tecnicos@cabadacomercial.com / ponteareas@cabadacomercial.com
 Web: www.cabadacomercial.com



ARTICULO	ROJA	GRAFITO
TEJA MIXTA	PVP €/ud	PVP €/ud
TEJA 440X265mm 12 uds/m2 Rastrel 37 cm 186 uds/palet	1.46	1.72
TEJA CUMBRERA	4.55	5.20
CUÑA	2.37	2.53
REMATE LATERAL DCHO/IZQ	4.56	5.20
REMATE UNIVERSAL	6.17	6.81
VENTILADORA	29.00	35.44
MEDIA TEJA	4.21	4.53
TAPÓN CUMBRERA	24.48	28.98
INICIO LIMATESA	24.48	28.99

ARTICULO	ROJA
TEJA MARSELLA	PVP €/ud
TEJA 440X255mm 12 uds/m2 Rastrel 38 cm 272 uds/palet	1.43
TEJA CUMBRERA	4.55
REMATE UNIVERSAL	6.17
TEJA VENTILADORA	29.00
MEDIA TEJA	4.21
TAPON CUMBRERA	24.48
INICIO LIMATESA	24.48

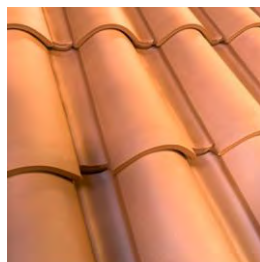

ARTICULO	ROJA	GRAFITO	SLATE
	PVP €/ud	PVP €/ud	PVP €/ud
TEJA PLANA			
TEJA 450X255 mm 12 uds/m2 Rastrel 37.5 cm 256 uds/palet	1.82	1.98	2.14
TEJA CUMBRERA	4.55	5.20	5.20
INICIO LIMATESA	24.48	28.99	28.99
TAPÓN CUMBRERA	24.48	28.98	28.98
MEDIA TEJA	4.21	4.86	4.86

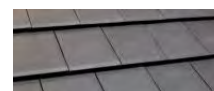
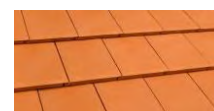

PALETS (se abonarán a su devolución)

4,00 €/UD

* IVA NO INCLUIDO

mar-25



TARIFA DE PRECIOS

ARTICULOS EN STOCK		PVP* (€/UD)
LADRILLO CARAVISTA ROJO	Medida: 240x115x50 432 uds/PALET Peso: 1,68 kg/ud 67 uds/m ²	0,30 €/UD
LADRILLO CARAVISTA MARRÓN		0,40 €/UD

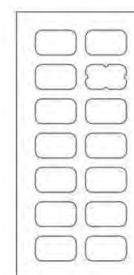
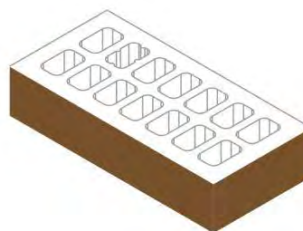

Gama de colores



Rojo



Rojo Inglés



Marrón



Marrón Oscuro

ARTICULOS BAJO PEDIDO PALES COMPLETOS NO ADMITE DEVOLUCIÓN		PVP* (€/UD)
LADRILLO CARAVISTA ROJO INGLES	Medida: 240x115x50 432 uds/PALET Peso: 1,68 kg/ud 67 uds/m ²	0,35 €/UD
LADRILLO CARAVISTA MARRÓN OSCURO		0,45 €/UD

* IVA NO INCLUIDO

mar-25

OFICINA: C/CARACAS, Nº10 (36203) VIGO – TFNOS. 986421617 / 986420560 FAX: 986483297
ALMACEN VINCOS: RUA OUTEIRO DO FERRO – POLIG. A PASAXE – VINCOS (GONDOMAR) – TFNO: 986467001
ALMACEN PONTEAREAS: LOMBA, 81 – AREAS (PONTEAREAS) – TFNO: 986640283
Mail: info@cabadacomercial.com / tecnicos@cabadacomercial.com / ponteareas@cabadacomercial.com
Web: www.cabadacomercial.com



TARIFA DE PRECIOS

ARTICULOS				PVP* (€/UD)
Tipos	Medidas	Ud/palet	Ud/m2	
HUECO DOBLE	24X11.5X8	384	33/45	0,176
LADRILLO REFRACTARIO	22X11X5	576		0,981
MEGATOSCO	30X19X12	120	16.6	0,632
TOSCO DE 10 (Rayado)	24X11.5X10	264	36	0,254
PERFORADO (<45%)	24X11.5X7	384	50	0,384
TABIQUERO DE 4.5	33X15X4.5	360	19	0,267
TABIQUERO DE 7	33X15X7	252	19	0,266
	50X20X7	140	9,4	0,555
TABIQUERO DE 8	33X15X8	216	19	0,289
	33x20x8	180	14	0,375
TABIQUERO DE 11	33X15X11	162	19	0,388
	33X20X11	135	14	0,489
TABIQUERO DE 4	40X20X4	240	11.62	0,367
TABLERO METRO 25	100X25X4	96	4	1,450
TABLERO METRO 30	100X30X4	72	3,3	1,755
TABLERO OCHENTA 25	80X25X4	96	5	1,158
ESCALÓN CERÁMICO	16.5X28X32.3	90		2,202
SATEBRICK ACUSTICO 11	40X20X11.5	70	12.5	1,157
SATEBRICK ACUSTICO 14	30X19X14.5	90	16.6	1,105
MEGABRICK TABIQUE	70.5X51.5X7	28	2.75	Consultar
MEGABRICK TABIQUE	70.5X30X11	27	4.73	Consultar



* IVA NO INCLUIDO

ene-25

OFICINA: C/CARACAS, N°10 (36203) VIGO – TFNOS. 986421617 / 986420560
 ALMACEN VINCOS: RUA OUTEIRO DO FERRO – POLIG. A PASAXE – VINCOS (GONDOMAR) – TFNO: 986467001
 ALMACEN PONTEAREAS: LOMBA, 81 – AREAS (PONTEAREAS) – TFNO: 986640283
 Mail: info@cabadacomercial.com / tecnicos@cabadacomercial.com / ponteareas@cabadacomercial.com
 Web: www.cabadacomercial.com



TARIFA DE PRECIOS



TERMOBRICK®

ARTICULOS					PVP* (€/UD)
Tipo		Medidas axbxc	Ud/palet	Ud/m2	
BASE	14	30X19X14	105	16.6	0,766
	19	30X19X19	75	16.6	0,990
	24	30X19X24	60	16.6	1,248
	29	30X19X29	45	16.6	1,502
MEDIOS (2 UD)	14	15X19X14	90		1,168
	19	15X19X19	75		1,646
	24	15X19X24	60		2,465
	29	15X19X29	45		3,352
REMATES	14	30X10X14 30X14X14	180 105		1,168
	19	30X10X19 30X14X19	150 105		1,646
	24	30X10X24 30X14X24	120 84		2,465
	29	30X10X29 30X14X29	90 63		3,352
TERMINACIÓN	14	30X19X14	105		1,168
	19	30X19X19	75		1,646
	24	30X19X24	60		2,465
	29	30X19X29	45		3,352
ZUNCHOS	14	24X19X14	120		1,168
	19	24X19X19	100		1,646
	24	24X19X24	80		2,465
	29	24X19X29	60		3,352
PIEZA AJUSTE	14	(5/10/5)X19X14	90		1,168
	19	(5/10/5)X19X19	75		1,646
	24	(5/10/5)X19X24	60		2,465
	29	(5/10/5)X19X29	45		3,352
ESQUINAS	14	29X19X14	90		1,168
	19	34X19X19	75		1,646
	24	39X19X24	40		2,465
	29	44X19X29	30		3,352

ARMADURA MURFOR	80	80x3,05x4		9,424
	100	100x3,05x4		9,424
	150	150x3,05x4		9,695
	200	200x3,05x5		10,153

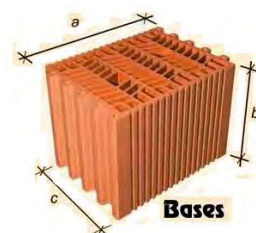
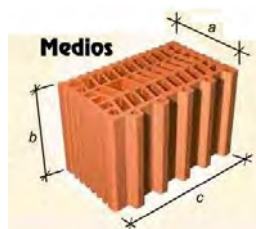
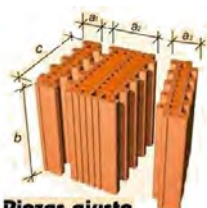
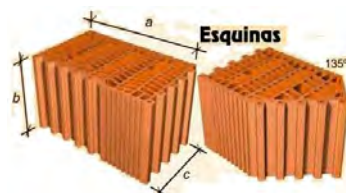
**Bases****Medios****Terminaciones****Zunchos****Piezas ajuste****Esquinas**

* IVA NO INCLUIDO

ene-25

OFICINA: C/CARACAS, N°10 (36203) VIGO – TFNOS. 986421617 / 986420560
 ALMACEN VINCOS: RUA OUTEIRO DO FERRO – POLIG. A PASAXE – VINCOS (GONDOMAR) – TFXO: 986467001
 ALMACEN PONTEAREAS: LOMBA, 81 – AREAS (PONTEAREAS) – TFXO: 986640283
 Mail: info@cabadacomercial.com / tecnicos@cabadacomercial.com / ponteareas@cabadacomercial.com
 Web: www.cabadacomercial.com



TARIFA DE PRECIOS

PLACA FIBROCEMENTO SISTEMA GRAN-ONDA	COLOR	MEDIDA (cm)	KG/UD	PVP* (€/UD)
		NATURAL	300 X 110	46
250 X 110			38	27,88
200 X 110			31	22,74
152 X 110			23	17,69
RÚSTICO ARCILLA		300 X 110	46	40,93
		250 X 110	38	32,86
		200 X 110	31	28,49
		152 X 110	23	21,28
PLACA PERFIL CURVA 190 (TEJA EURONIT-UM de 16 y 18 cm)	RUSTICO ARCILLA	250 X 98.7	35	36,62
		152 X 98.7	21	23,05
PLACA PERFIL CURVA 230 (TEJA DE BOCA 18 – 22 cm)	TEJA	250 X 96.4	33	36,62
		152 X 96.4	20	23,05
PLACA PERFIL TEJA MIXTA	RÚSTICO ARCILLA	250 X 100	32	36,62
		125 X 100	16	21,19
PLACA ETERBOARD MD de 9mm	NATURAL	250X122	40	91,46

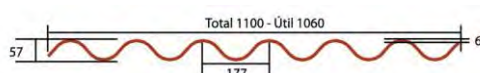

PLACA GRAN ONDA

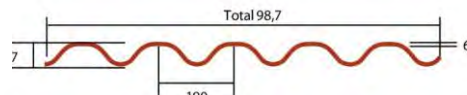

PERFIL CURVA 190

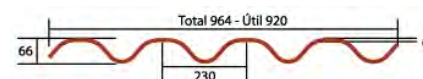

PERFIL CURVA 230

PERFIL MIXTA

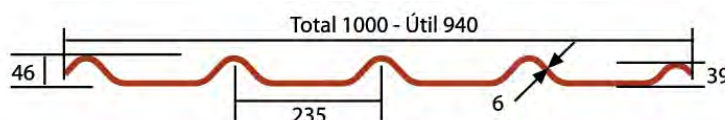

PLACA ETERBOARD
MD



COMPLEMENTOS DE CUBIERTA		PVP* (€/UD)
CABALLETE ANGULAR 120X30 136°	NATURAL	24,88
	RÚSTICO ARCILLA	25,83
CABALLETE ARTICULADO COMPLETO	NATURAL	28,69
	RÚSTICO ARCILLA	35,52



* IVA NO INCLUIDO

jun-24

OFICINA: C/CARACAS, Nº10 (36203) VIGO – TFNOS. 986421617 / 986420560

ALMACEN VINCICIOS: RUA OUTEIRO DO FERRO – POLIG. A PASAXE – VINCICIOS (GONDOMAR) – TFNO: 986467001





ALMACEN PONTEAREAS: LOMBA, 81 – AREAS (PONTEAREAS) – TFNO: 986640283

Mail: info@cabadacomercial.com / tecnicos@cabadacomercial.com / ponteareas@cabadacomercial.com

Web: www.cabadacomercial.com



TARIFA DE PRECIOS

ONDULINE BAJO TEJA – color rojo –					
Artículo	Aplicación	Medida			PVP *
		Largo (m)	Ancho (m)	Altura Onda (mm)	€/UD
BT 50	Teja con encaje y pizarra 	2.00	1.00	24	16,90
BT 235	Teja curva entre 18.5-22 cm 	2.00	1.05	38	17,50
BT 200	Teja curva entre 14-18 cm 	2.00	1.05	24	16,55
BT 190	Teja curva + de 22 cm 	2.00	0.95	36	16,65

Nota: Pendientes recomendada entre 10 y 70 % (para pendientes superiores al 50% con las placas BT235 y BT190, se recomienda colocar un listón por debajo de las ondas en las que vaya la fijación).

Colocación de placa Bajo Teja.

- Se colocarán de alero a cumbrera y en sentido contrario a los vientos dominantes.
- En caso de incorporar un elemento aislante, se colocará encima del forjado y debajo de las placas Bajo Teja.
- Se fijarán siempre mecánicamente y por la parte alta de la onda. La fijación debe atravesar las placas Onduline Bajo Teja y el aislamiento (cuando exista) llegando al forjado. El tipo y longitud de la fijación vienen determinados por el tipo de forjado y el espesor del aislamiento. Ver tornillería y accesorios.
- La fijación de las placas BT-150PLUS y BT-200 se realizará en las ondas centrales de forma que no se obstaculice el asentamiento de la teja canal.



- En los solapes, la fijación se realizará a 7cm del borde de la placa.
- No se recomienda la instalación a una temperatura ambiental inferior a 1°C o superior a 40°C.
- En zonas de la cubierta en las que el instalador deba estar más tiempo sobre las placas o por las que deba transitar más, se deberá colocar un tablón para repartir mejor el peso de este entre las ondas de las placas.

Solapes

Pendientes (%)	Nº de Fijaciones por placa	Repercusión x m ²	Distribución
Menor de 40	9	3	3 en el solape inferior, 3 en la parte central y 3 en el solape superior
Mayor de 40	12	3,5	4 en el solape inferior, 4 en la parte central y 4 en el solape superior

Pendientes (%)	Solape mínimo Longitudinal (cm)
Menos de 20	30
Más de 20	15

Placa Bajo Teja	Solape mínimo Lateral (nº de ondas)
BT - 235	1
BT - 150PLUS	2
BT - 200	1
BT - 190	1

* IVA NO INCLUIDO

jun-24

OFICINA: C/CARACAS, Nº10 (36203) VIGO – TFNOS. 986421617 / 986420560 FAX: 986483297
 ALMACEN VINCIOS: RUA OUTEIRO DO FERRO – POLIG. A PASAXE – VINCIOS (GONDOMAR) – TFNO: 986467001
 ALMACEN PONTEAREAS: LOMBA, 81 – AREAS (PONTEAREAS) – TFNO: 986640283



Mail: info@cabadacomercial.com / tecnicos@cabadacomercial.com / ponteareas@cabadacomercial.com

Web: www.cabadacomercial.com



TARIFA DE PRECIOS



ONDUCOBER					
Artículo	Aplicación	Medida			PVP
		Largo (m)	Ancho (m)	Altura Onda (mm)	€/UD
NEGRO	CUBIERTA, SOBRECUBIERTA Y PARAMENTO 	2.00	0.95	38	15,65
ROJO		2.00	0.95	38	16,65
VERDE		2.00	0.95	38	17,90
GRIS		2.00	0.95	36	18,85
ACCESORIOS					
Artículo	Color	Aplicación	Dimensiones		PVP (€/UD)
CUMBRERA	Negra	Cubierta y sobrecubierta 	1000x500 mm		8,56
	Roja				9,32
	Verde				13,05
REMATE ONDUCOBER	Rojo, Negro, Verde, Gris	 Paramentos A=10CM B= 7 CM	2000x100x70 mm		14,82

ONDUVILLA – Teja Asfáltica –				
Artículo	Color	Características		PVP *
SOMBREADO	Rojo y negro	Dimensiones: 40 cm x 106 cm (largo x ancho) Espesor 3 mm Altura Onda: 40 mm // N° Ondas: 6 N° Placas por m2: 3.225 N° Placas por pqte: 7 Superficie útil paquete: 2.17 m2		5,65 €/UD
SOMBREADO	Verde			6,00 €/UD
SOMBREADO	Marrón			5,30 €/UD
ACCESORIOS				
TORNILLO UNIVERSAL DE 6.5		6.5 cm (6 cm útiles) // CAJA 100 UD		11,58 €/Caja
CUMBRERA	SOMBREADO	Largo: 90 cm Ancho: 50 cm		11,15 €/UD

* IVA NO INCLUIDO

jun-24

OFICINA: C/CARACAS, Nº10 (36203) VIGO – TFNOS. 986421617 / 986420560
 ALMACEN VINCOS: RUA OUTEIRO DO FERRO – POLIG. A PASAXE – VINCOS (GONDOMAR) – TFNO: 986467001
 ALMACEN PONTEAREAS: LOMBA, 81 – AREAS (PONTEAREAS) – TFNO: 986640283
 Mail: info@cabadacomercial.com / tecnicos@cabadacomercial.com / ponteareas@cabadacomercial.com
 Web: www.cabadacomercial.com



TARIFA DE PRECIOS

ACCESORIOS				
Artículo	Aplicación	Dimensiones	Ud/pqte	PVP *
FLASHING BAND	Impermeabilización o sellado de remates de chimenea, alero, etc. Color: ROJO	2.50MX30CM	4	17,90 €/UD
PEINE VENTILACIÓN	Remate de alero anti-pájaros Color negro 	100x8 cm	1	4,47 €/UD
TORNILLO UNIVERSAL	soporte de madera / metal	Longitud:6,5 cm (6 cm útiles)	100	11,58 €/CAJA
CLAVO ESPIRAL	Fijación de BT50,BT150,BT190,BT200 Y BT235 a soporte de madera 	Longitud: 8 cm	200	16,24 €/CAJA
		Longitud: 11.5 cm	200	0,10 €/UD
CLAVO CABEZA PVC	Fijación de BT150,BT190,BT200 Y BT235, y onducober a soporte de madera 	Longitud: 6 cm	400	0,08 €/UD
		Longitud: 7 cm	400	0,08 €/UD
CLAVO TACO	Fijación de BT50, BT150,BT190,BT200 Y BT235, y onducober a soporte de HORMIGÓN 	Longitud: 9 cm	200	23,05 €/CAJA
		Longitud: 13 cm	200	34,41 €/CAJA
ARANDELA	Clavo espiral y clavo taco 	2 x 2 x 0.3 cm	200	0,05 €/UD

* IVA NO INCLUIDO

feb-23

OFICINA: C/CARACAS, N°10 (36203) VIGO – TFNOS. 986421617 / 986420560
 ALMACEN VINCOS: RUA OUTEIRO DO FERRO – POLIG. A PASAXE – VINCOS (GONDOMAR) – TFNO: 986467001
 ALMACEN PONTEAREAS: LOMBA, 81 – AREAS (PONTEAREAS) – TFNO: 986640283
 Mail: info@cabadacomercial.com / tecnicos@cabadacomercial.com / ponteareas@cabadacomercial.com
 Web: www.cabadacomercial.com



TARIFA DE PRECIOS

ONDUTHERM

TARIMA NATURAL 16mm	YESO 13mm	TABLERO OSB 10mm
H19+A30+TN16	H16+A30+Y13	H19+A30+OSB10
H19+A40+TN16	H16+A40+Y13	H19+A40+OSB10
H19+A50+TN16	H16+A50+Y13	H19+A50+OSB10
H19+A60+TN16	H16+A60+Y13	H19+A60+OSB10
H19+A80+TN16	H16+A80+Y13	H19+A80+OSB10
H19+A100+TN16	H16+A100+Y13	H19+A100+OSB10



Barnizado Nogal 10mm	Natural 10mm	Barnizado 10 mm
H16+A30+FABN10	H16+A30+FAN10	H19+A30+FAB10
H16+A40+FABN10	H16+A40+FAN10	H19+A40+FAB10
H16+A50+FABN10	H16+A50+FAN10	H19+A50+FAB10
H16+A60+FABN10	H16+A60+FAN10	H19+A60+FAB10
H16+A80+FABN10	H16+A80+FAN10	H19+A80+FAB10
H16+A100+FABN10	H16+A100+FAN10	H19+A100+FAB10

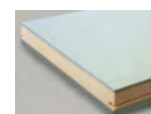

TABLERO CEMENTO MADERA 10mm	TABLERO AGLOMERADO HIDRÓFUGO 10mm
H16+A30+CM10	H19+A30+H10
H16+A40+CM10	H19+A40+H10
H16+A50+CM10	H19+A50+H10
H16+A60+CM10	H19+A60+H10
H16+A80+CM10	H19+A80+H10
H16+A100+CM10	H19+A100+H10



Friso abeto natural 13mm	Tablero aglomerado hidrófugo 16mm
A30+FAN13	A30+H16
A40+FAN13	A40+H16
A50+FAN13	A50+H16
A60+FAN13	A60+H16
A80+FAN13	A80+H16
A100+FAN13	A100+H16

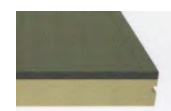

PRECIOS A CONSULTAR.

Producto bajo pedido. Consultar plazos de entrega.

oct-22



TARIFA DE PRECIOS

Onduclair: Productos Plásticos

ROLLO POLIÉSTER		PVP*																									
		€/M2	€/UD																								
 <p>ROLLO PLR LISO</p> <table border="1"> <tr> <td>Ancho</td> <td>Largo (m)</td> <td>Espesor</td> </tr> <tr> <td>1,25 m</td> <td>30</td> <td>1 mm</td> </tr> <tr> <td>Peso (kg/m²)</td> <td colspan="2">Transmisión Luminosa</td> </tr> <tr> <td>1,33</td> <td colspan="2">83 %</td> </tr> </table> <p>ROLLO PLR ONDULADO</p> <table border="1"> <tr> <td>Ancho</td> <td>Largo (m)</td> <td>Espesor</td> </tr> <tr> <td>1,25 m</td> <td>30</td> <td>0,7 mm</td> </tr> <tr> <td>Peso (kg/m²)</td> <td colspan="2">Transmisión Luminosa</td> </tr> <tr> <td>1,04</td> <td colspan="2">83 %</td> </tr> </table>	Ancho	Largo (m)	Espesor	1,25 m	30	1 mm	Peso (kg/m ²)	Transmisión Luminosa		1,33	83 %		Ancho	Largo (m)	Espesor	1,25 m	30	0,7 mm	Peso (kg/m ²)	Transmisión Luminosa		1,04	83 %		LISO	9,26	347,17
	Ancho	Largo (m)	Espesor																								
1,25 m	30	1 mm																									
Peso (kg/m ²)	Transmisión Luminosa																										
1,33	83 %																										
Ancho	Largo (m)	Espesor																									
1,25 m	30	0,7 mm																									
Peso (kg/m ²)	Transmisión Luminosa																										
1,04	83 %																										
	ONDULADO	6,79	254,50																								

PLACA POLIÉSTER		Largo m	PVP*																									
			€/M2	€/UD																								
 <p>MINI ONDA PLR</p> <table border="1"> <tr> <td>Ancho</td> <td>Largo (m)</td> <td>Espesor</td> </tr> <tr> <td>1,12 m</td> <td>1,5 - 2 - 2,5 - 3</td> <td>1 mm</td> </tr> <tr> <td>Peso (kg/m²)</td> <td colspan="2">Transmisión Luminosa</td> </tr> <tr> <td>1,58</td> <td colspan="2">85 %</td> </tr> </table> <p>GRAN ONDA PLR</p> <table border="1"> <tr> <td>Ancho</td> <td>Largo (m)</td> <td>Espesor</td> </tr> <tr> <td>1,1 m</td> <td>1,5 - 2 - 2,5 - 3</td> <td>1 mm</td> </tr> <tr> <td>Peso (kg/m²)</td> <td colspan="2">Transmisión Luminosa</td> </tr> <tr> <td>1,68</td> <td colspan="2">85 %</td> </tr> </table>	Ancho	Largo (m)	Espesor	1,12 m	1,5 - 2 - 2,5 - 3	1 mm	Peso (kg/m ²)	Transmisión Luminosa		1,58	85 %		Ancho	Largo (m)	Espesor	1,1 m	1,5 - 2 - 2,5 - 3	1 mm	Peso (kg/m ²)	Transmisión Luminosa		1,68	85 %		MINI ONDA	1,52	9,59	16,33
	Ancho	Largo (m)	Espesor																									
	1,12 m	1,5 - 2 - 2,5 - 3	1 mm																									
	Peso (kg/m ²)	Transmisión Luminosa																										
	1,58	85 %																										
	Ancho	Largo (m)	Espesor																									
	1,1 m	1,5 - 2 - 2,5 - 3	1 mm																									
	Peso (kg/m ²)	Transmisión Luminosa																										
1,68	85 %																											
2,00	21,49																											
2,50	26,86																											
3,00	32,23																											
GRAN ONDA	1,52	9,59	16,04																									
	2,00		21,10																									
	2,50		26,38																									
	3,00		31,66																									

PLACA POLICARBONATO		Largo m	PVP*																									
			€/M2	€/UD																								
 <p>MINI ONDA PC</p> <table border="1"> <tr> <td>Ancho</td> <td>Largo (m)</td> <td>Espesor</td> </tr> <tr> <td>1,12 m</td> <td>1,5 - 2 - 2,5 - 3</td> <td>0,8 mm</td> </tr> <tr> <td>Peso (kg/m²)</td> <td colspan="2">Transmisión Luminosa</td> </tr> <tr> <td>1,06</td> <td colspan="2">90 %</td> </tr> </table> <p>GRAN ONDA PC</p> <table border="1"> <tr> <td>Ancho</td> <td>Largo (m)</td> <td>Espesor</td> </tr> <tr> <td>1,1 m</td> <td>1,5 - 2 - 2,5 - 3</td> <td>1 mm</td> </tr> <tr> <td>Peso (kg/m²)</td> <td colspan="2">Transmisión Luminosa</td> </tr> <tr> <td>1,44</td> <td colspan="2">90 %</td> </tr> </table>	Ancho	Largo (m)	Espesor	1,12 m	1,5 - 2 - 2,5 - 3	0,8 mm	Peso (kg/m ²)	Transmisión Luminosa		1,06	90 %		Ancho	Largo (m)	Espesor	1,1 m	1,5 - 2 - 2,5 - 3	1 mm	Peso (kg/m ²)	Transmisión Luminosa		1,44	90 %		MINI ONDA	1,52	14,80	25,20
	Ancho	Largo (m)	Espesor																									
	1,12 m	1,5 - 2 - 2,5 - 3	0,8 mm																									
	Peso (kg/m ²)	Transmisión Luminosa																										
	1,06	90 %																										
	Ancho	Largo (m)	Espesor																									
	1,1 m	1,5 - 2 - 2,5 - 3	1 mm																									
	Peso (kg/m ²)	Transmisión Luminosa																										
1,44	90 %																											
2,00	33,15																											
2,50	41,44																											
3,00	49,73																											
GRAN ONDA	1,52	14,80	24,75																									
	2,00		32,56																									
	2,50		40,70																									
	3,00		48,84																									

* IVA NO INCLUIDO

oct-22

OFICINA: C/CARACAS, Nº10 (36203) VIGO – TFNOS. 986421617 / 986420560 FAX: 986483297
 ALMACEN VINCIOS: RUA OUTEIRO DO FERRO – POLIG. A PASAXE – VINCIOS (GONDOMAR) – TFNO: 986467001
 ALMACEN PONTEAREAS: LOMBA, 81 – AREAS (PONTEAREAS) – TFNO: 986640283
 Mail: info@cabadacomercial.com / tecnicos@cabadacomercial.com / ponteareas@cabadacomercial.com
 Web: www.cabadacomercial.com



TARIFA DE PRECIOS

Onduclair: Productos Plásticos

PLACA PC CELULAR	ESPESOR mm	Nº PAREDES	LARGO m	PVP*	
				€/M2	€/UD
	4	2	2,00	9,73	19,07
	6	2	2,00	14,94	29,28
	10	2	2,00	18,60	36,46
			3,00		54,69
	16	5	2,00	30,20	59,20
			3,00		88,80
		Diamante	2,00	23,25	45,57
			3,00		68,36

PRODUCTO	PERFIL	ESPESOR (mm)	Nº DE PAREDES	PESO (kg/m ²)	ANCHO (m)	LARGO (m)
PC CELULAR 4		4	2	0,80	0,98	2
PC CELULAR 6		6	2	1,30	0,98	2
PC CELULAR 10		10	2	1,50	0,98	2-3
PC CELULAR 16		16	5	1,90	0,98	2-3
PC CELULAR 16		16	Diamante	2,50	0,98	2-3

Accesorios Policarbonato	ESPESOR mm	LARGO m	PVP* €/UD
PERFIL H	4,00	2,00	10,85
	6,00	2,00	10,85
	10,00	2,00	12,08
		3,00	18,13
	16,00	2,00	16,44
		3,00	24,66
PERFIL U	4,00	2,10	3,28
	6,00	2,10	3,28
	10,00	2,10	4,40
	16,00	2,10	6,90

ACCESORIOS	Perfil	LARGO (L x A)
PERFIL H PERFIL U		2 m (PC 4-6mm) / 2-3 (PC 10-16 mm) 2,1 m

* IVA NO INCLUIDO

oct-22

OFICINA: C/CARACAS, Nº10 (36203) VIGO – TFNOS. 986421617 / 986420560 FAX: 986483297
 ALMACEN VINCIOS: RUA OUTEIRO DO FERRO – POLIG. A PASAXE – VINCIOS (GONDOMAR) – TFNO: 986467001
 ALMACEN PONTEAREAS: LOMBA, 81 – AREAS (PONTEAREAS) – TFNO: 986640283
 Mail: info@cabadacomercial.com / tecnicos@cabadacomercial.com / ponteareas@cabadacomercial.com
 Web: www.cabadacomercial.com



TARIFA DE PRECIOS

Artículo	Descripción	A	B	C	Espesor	PVP* (€/UD)
(004010) OMEGA DE 15X15X29X0,6 DE 5 ML	Perfil acero galvanizado Construcción de estructura para teja.	15	15	29	0,6	7,20
(004025) OMEGA DE 17X30X20X0,6 DE 5 ML		17	30	20	0,6	9,00

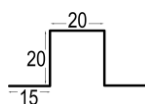
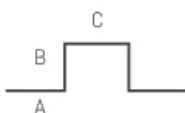
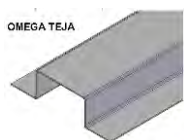

ARTICULOS		PVP* (€/UD)
(LM) LISTON METÁLICO 15x20x20x0.6mm DE 2m	Perfil acero galvanizado lacado blanco . Apoyo para teja mixta, plana o de hormigón.	2,95

ARTICULO		PVP* (€/UD)	
(GTI) GANCHO TEJA INOX	72 x12 x 20 x2.4	0,05	
ARTICULOS		PVP* (€/UD)	
VARILLA RECTA M7	Ø6 350MM	Fabricada en acero Anclaje para chapas metálicas y de fibrocemento	0,32
	Ø6 400MM		0,34
GANCHO FIBROCEMENTO DE 6	230X115X20	Fabricado en alambre de acero Sujeción de cubiertas metálicas o de fibrocemento a viguetas metálicas o de hormigón	0,26
	260X115X20		0,27
ARTICULOS		PVP* (€/UD)	
TORNILLO ROSCA SALOMÓNICA Ø 6 longitud:110 mm	Fabricada en alambre de acero Sujeción de cubiertas metálicas y de fibrocemento a madera	0,18	



ARTICULOS		PVP* (€/UD)
CHAPA TRASLUZ GRAN-ONDA Equipada	Fabricada en chapa galvanizada Ø 6 MM	0,09
CHAPA MINI-ONDA Equipada		0,11
APOYAONDAS GRAN-ONDA altura 50mm	Fabricada en polipropileno Apoyo de chapas traslúcidas gran-onda	0,16
APOYAONDAS MINI-ONDA altura 18 mm	Fabricada en polipropileno Apoyo de chapas mini-onda	0,11



Chapa Trasluz



Chapa Minionda



APOYAONDA MINI-ONDA

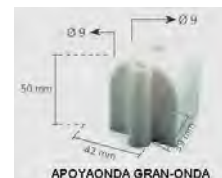

APOYAONDA GRAN-ONDA



ARTICULO	PVP* (€/UD)
CAPERUZA PLÁSTICA PARA TORNILLO	0,08

* IVA NO INCLUIDO

ene-24

OFICINA: C/CARACAS, Nº10 (36203) VIGO – TFNOS. 986421617 / 986420560
 ALMACEN VINCOS: RUA OUTEIRO DO FERRO – POLIG. A PASAXE – VINCOS (GONDOMAR) – TFNO: 986467001
 ALMACEN PONTEAREAS: LOMBA, 81 – AREAS (PONTEAREAS) – TFNO: 986640283
 Mail: info@cabadacomercial.com / tecnicos@cabadacomercial.com / ponteareas@cabadacomercial.com
 Web: www.cabadacomercial.com



TARIFA DE PRECIOS



CÓDIGO	ARTÍCULO	PVP (€/M)	PVP (€/UD)
020110160	Lámina transpirable impermeable USB CLASSIC 185 gr/m2 1.50mx50m-75m2 (CUBIERTAS) *Hasta final de stock	1,73 M ²	129.62
02010191	Membrana impermeable traspirable DO135 143gr/m2 1.50mx50m-75m2 (CUBIERTAS) *Hasta final de stock	0,99 M ²	74,00
02010090	Membrana impermeable transpirable USB WALL 120 120 gr/m2 1.50mx50m-75m2 (FACHADAS) *Hasta final de stock	1,25 M ²	93,50
02040160	Cinta adhesiva USB TAPE 1 PE 60mmx25m – Cinta adhesiva flexible de polietileno. Adhesión inicial: MUY ALTA	0,73 ML	18.25
02040162	Cinta adhesiva USB TAPE RAPID 60mmx50m – Cinta acrílica de una cara, ausencia de liner.	0,59 ML	29.50
020401616	Cinta adhesiva TAPE GREEN 60mmx25m – Cinta adhesiva flexible de polietileno. Adhesión inicial: ALTA.	0,43 ML	10.75
02040250	Cinta adhesiva de doble cara TAPE 2 AC 50mmx50m	0,43 ML	21.50
02064007	Pantalla barrera total vapor DS 1500 SYN 130g/m2 50mx1.5m – ANTI RADÓN	3,70 M ²	277.40



CÓDIGO	ARTÍCULO	PVP
ABV90	Barrera de vapor AISREC DE 1.50mx50m (75m2) - 90 gr (2 capas)	72,00
AIT130	AISREC – Lámina transpirable impermeable 130 gr - 75m2	64,40
AIBT29815X20	AISREC – Impermeable de baños 1,5 x 20 m	154,50
KIDA1	Kit impermeabilización y desagüe AISREC MOD 1	22,65
CA1C5025	CINTA ADHESIVA 1 CARA 50mmx25m Para unión y reparaciones de lám. Imperm -transp.	11,90
05RUL001	RODILLO DE PLÁSTICO RÍGIDO	1,92



* IVA NO INCLUIDO

ene-24



TARIFA DE PRECIOS

ARTICULOS				PVP* (€/UD)
T881	TORNILLO PREMONTADO (con taco) Ø 4.8mm	8x80	Colocación rastrel * Los de 120 y 140 se recomiendan para colocación de chapa fibrocemento en placas de hormigón.	0,11
TB810		8x100		0,13
T8120		8x120		0,16
TB814		8x140		0,18



ARTICULO			PVP* (€/UD)
CC25RT	CLIP CUMBRERA 25 R MIXTA	Fabricado en aluminio prelacado rojo teja Apto para teja curva de 15 a 25 mm espesor	0,31
SC50	SOPORTE CABALLETE RASTREL 50 MM	Fabricado en chapa acero galvanizada	1,18
LA500X2R	LIMAHOYA ALU 500MMX2M ROJA	Impermeab. de canales longitudinales	22,00
LEADAX1000	LEADAX ANCHO 1M x 6M	Alternativa al PLOMO con las mismas propiedades. Color GRIS o ROJO	321,75
LEADAX333	LEADAX ANCHO 33CM x 6M		107,25
1651AR	PEINE ANTIPAJAROS 100X2,5+5,5	Cierrateja con listelo perforado para techos ventilados	1,30
TER131652P	PEINE UNIVERSAL PLASTICO ROJO	Elemento adaptable al perfil de tejas	1,25
1651LR	RASTREL PERFORADO ROJO 100X2.5	Para cubiertas ventiladas	1,05
RVA400	ROLL-VENT ALU 400mm x 5m	Remate para cumbreras y limatesas ventiladas	21,31

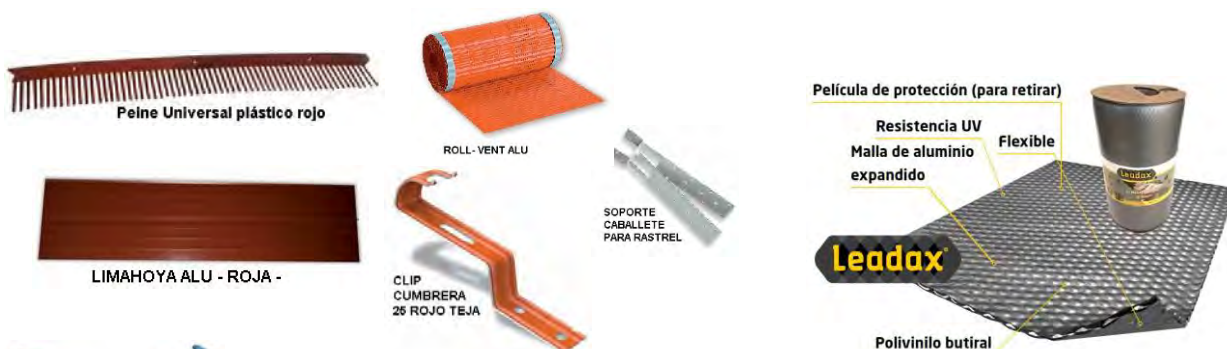

ACCESORIOS PARA TEJA VEREA	
ARTICULO	PVP* (€/UD)
ESPUMA PISTOLA DE 750 ML	7,61
ESPUMA CANULA 750 ML	8,13
LIMPIADOR ESPUMA BOTE 500 ML	9,20
PISTOLA PARA ESPUMA	57,20
CONJUNTO PLETINA + TORNILLO	3,22
TORNILLO PLETINA 3.5X35	0,04
PERFIL CUMBRERA 3000X30X1.3	11,80
UNION PERFIL	0,31
GRAPA SUJECCION CUMBRERA	0,56
TORNILLO 48X38 CUMBRERA	0,08

* IVA NO INCLUIDO

mar-25

OFICINA: C/CARACAS, Nº10 (36203) VIGO – TFNOS. 986421617 / 986420560
 ALMACEN VINCOS: RUA OUTEIRO DO FERRO – POLIG. A PASAXE – VINCOS (GONDOMAR) – TFNO: 986467001
 ALMACEN PONTEAREAS: LOMBA, 81 – AREAS (PONTEAREAS) – TFNO: 986640283
 Mail: info@cabadacomercial.com / tecnicos@cabadacomercial.com / ponteareas@cabadacomercial.com
 Web: www.cabadacomercial.com



TARIFA DE PRECIOS

ARTÍCULO	PVP *	
PANEL SIMPLE DE 3 o 5 GRECAS – MODELO C1 – PERFIL 40 MM (cortado a medida en múltiplos de 0.50) Espesor de chapa 0.5mm	17,90 €/M2	
PANEL CON AISLAMIENTO DE 3 o 5 GRECAS – MODELO C1 (aislante de poliuretano de 30 mm y acabado en chapa prelacada blanca)	3 GRECAS	28,00 €/M2
	5 GRECAS	24,00 €/M2
PANEL TEJA CON AISLAMIENTO DE 40 MM y acabado en chapa prelacada roja/blanca (Cortada a medida en múltiplos de 0.35)	41,40 €/M2	
REMATE FRONTAL PANEL TEJA 1 ML	12,10 €/UD	
CUMBRERA DOBLE EN DOS MITADES DE 1 ML	54,95 €/UD	
REMATE TRASERO TROQUELADO 1 ML	20,00 €/UD	
REMATE LATERAL PANEL TEJA DE 3 ML DE 40MM ESPESOR	24,40 €/UD	

Precios orientativos debido a las variaciones en el mercado

CHAPA PERFILADA MODELO SERIE C1

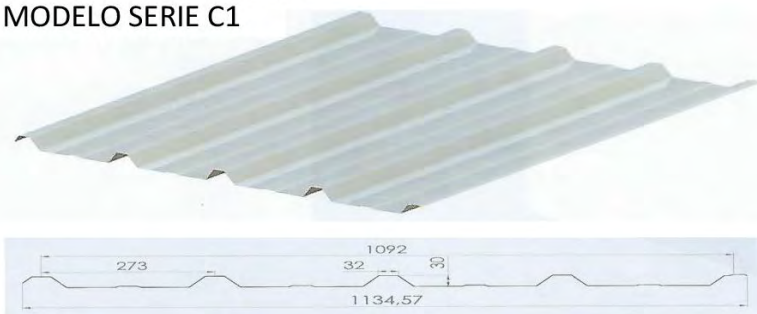

PANEL TIPO TEJA MODELO SERIE C1



PANEL DE CUBIERTA MODELO SERIE C1-5-1000

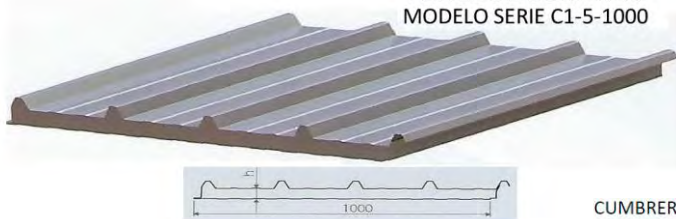

REMATE FRONTAL



CUMBRERA DOBLE EN 2 MITADES



REMATE LATERAL D-250



REMATES TRASEROS TROQUELADOS D-416



* IVA NO INCLUIDO

dic-23

OFICINA: C/CARACAS, Nº10 (36203) VIGO – TFNOS. 986421617 / 986420560 FAX: 986483297
 ALMACEN VINCOS: RUA OUTEIRO DO FERRO – POLIG. A PASAXE – VINCOS (GONDOMAR) – TFNO: 986467001
 ALMACEN PONTEAREAS: LOMBA, 81 – AREAS (PONTEAREAS) – TFNO: 986640283
 Mail: info@cabadacomercial.com / tecnicos@cabadacomercial.com / ponteareas@cabadacomercial.com
 Web: www.cabadacomercial.com



TARIFA DE PRECIOS

SANITARIO						
ARTICULO	CM	Uds/m2	Uds/palet	M2/palet	PVP (€/m2)	PVP (€/ud)
COFRATTO						
H 5	50 X 50	4	600	150	8.58	2.15
H10	50 X 50	4	400	100	11.11	2.78
FERRACIN						
H15	58 X 58	3	340	113.33	11.70	3.90
H20	58 X 58	3	340	113.33	12.09	4.03
H25	58 X 58	3	340	113.33	12.48	4.16
H30	56 X 56	3.2	260	81.25	14.50	4.53
H35	56 X 56	3.2	260	81.25	14.72	4.60
H40	56 X 56	3.2	220	68.75	16.86	5.27
H45	56 X 56	3.2	220	68.75	17.18	5.37
H50	56 X 56	3.2	220	68.75	17.89	5.59
H60	71 X 71	2	60	30.00	26.06	13.03
H65	71 X 71	2	60	30.00	26.52	13.26



ENTRA EN VIGO EL 16 DE MAYO DE 2024

* IVA NO INCLUIDO

may-24

OFICINA: C/CARACAS, Nº10 (36203) VIGO – TFNOS. 986421617 / 986420560
 ALMACEN VINCIOS: RUA OUTEIRO DO FERRO – POLIG. A PASAXE – VINCIOS (GONDOMAR) – TFNO: 986467001
 ALMACEN PONTEAREAS: LOMBA, 81 – AREAS (PONTEAREAS) – TFNO: 986640283
 Mail: info@cabadacomercial.com / tecnicos@cabadacomercial.com / ponteareas@cabadacomercial.com
 Web: www.cabadacomercial.com



TARIFA DE PRECIOS

TUBOS PARA ENCOFRADO

PILAR CIRCULAR LISO		
DIÁMETRO	LONGITUD	PVP (€/ML)
200 *	3 ML	11,77
250	3 ML	15,72
250	4 ML	15,72
300	3 ML	19,05
300	4 ML	19,05
350 *	3 ML	21,08
400 *	3 ML	26,43



* hasta fin existencias.

MAJLA ELECTROSOLDADA

ARTICULOS		PVP* (€/UD)
MALLAZO 30X20X5	MEDIDA: 6X2.20 13.20 M2 PRECIOS ORIENTATIVOS - CONSULTAR -	15,76
MALLAZO 15X15X5		25,73
MALLAZO 15X15X6		37,08
MALLAZO 15X15X8		63,51
MALLAZO 15X15X10		100,66
MALLAZO 15X15X12		135,55
MALLAZO 20X20X5		20,26
MALLAZO 20X20X6		27,81
MALLAZO 20X20X8		47,00
MALLAZO 20X20X10		74,53
MALLAZO 20X20X12		103,07



Fibra PP

ARTICULOS	PVP* (€/UD)
FIBRA PP 12 MM BOLSA DE 600 GR	3.09

* Fibra para hormigón. Fabricada en polipropileno.
Se utiliza para que la parte superior del hormigón no se agriete.



* IVA NO INCLUIDO

1 de Noviembre de 2023

OFICINA: C/CARACAS, N°10 (36203) VIGO – TFNOS. 986421617 / 986420560
 ALMACEN VINCIOS: RUA OUTEIRO DO FERRO – POLIG. A PASAXE – VINCIOS (GONDOMAR) – TFNO: 986467001
 ALMACEN PONTEAREAS: LOMBA, 81 – AREAS (PONTEAREAS) – TFNO: 986640283
 Mail: info@cabadacomercial.com / tecnicos@cabadacomercial.com / ponteareas@cabadacomercial.com
 Web: www.cabadacomercial.com



TARIFA DE PRECIOS VIGUETA ARMADA

ARTICULOS		PVP* (€/ML)	ARTICULOS		PVP* (€/ML)
CUBIERTA			VIVIENDA		
12	V1 HASTA 2,70 ML	CONSULTAR	17	V1 HASTA 2,50 ML	CONSULTAR
	V2 HASTA 3,30 ML			V2 HASTA 3,10 ML	
	V3 HASTA 3,80 ML			V3 HASTA 3,40 ML	
	V4 HASTA 3,90 ML			V4 HASTA 3,50 ML	
	V5 HASTA 4,20 ML			V5 HASTA 3,90 ML	
	V6 HASTA 4,50 ML			V6 HASTA 4,20 ML	
	V7 HASTA 4,70 ML			V7 HASTA 4,30 ML	
	V8 HASTA 4,90 ML			V8 HASTA 4,50 ML	
	V9 HASTA 5,30 ML			V9 HASTA 4,90 ML	
	V10 HASTA 5,40 ML			V13 HASTA 5,50 ML	
	V11 HASTA 5,50 ML				
17	V1 HASTA 3,10 ML	CONSULTAR	20	V1 HASTA 3,00 ML	CONSULTAR
	V2 HASTA 3,80 ML			V2 HASTA 3,20 ML	
	V3 HASTA 4,30 ML			V3 HASTA 3,70 ML	
	V4 HASTA 4,40 ML			V5 HASTA 4,10 ML	
	V5 HASTA 4,80 ML			V6 HASTA 4,40 ML	
	V6 HASTA 5,20 ML			V7 HASTA 4,60 ML	
	V7 HASTA 5,40 ML			V8 HASTA 4,80 ML	
	V8 HASTA 5,60 ML			V9 HASTA 5,20 ML	
	V9 HASTA 6,00 ML			V11 HASTA 5,60 ML	
	V10 HASTA 6,10 ML			V13 HASTA 5,90 ML	
	V11 HASTA 6,30 ML			V14 HASTA 6,00 ML	
20	V1 HASTA 4,00 ML	CONSULTAR	25	V1 HASTA 3,00 ML	CONSULTAR
	V2 HASTA 4,10 ML			V2 HASTA 3,50 ML	
	V3 HASTA 4,60 ML			V3 HASTA 3,90 ML	
	V4 HASTA 4,70 ML			V4 HASTA 4,00 ML	
	V5 HASTA 5,20 ML			V5 HASTA 4,40 ML	
	V6 HASTA 5,50 ML			V6 HASTA 4,70 ML	
	V7 HASTA 5,80 ML			V7 HASTA 4,90 ML	
	V8 HASTA 6,00 ML			V8 HASTA 5,20 ML	
	V9 HASTA 6,50 ML			V9 HASTA 5,50 ML	
	V11 HASTA 6,90 ML			V10 HASTA 5,60 ML	
	25			V1 HASTA 4,70 ML	
V3 HASTA 4,80 ML		V13 HASTA 6,30 ML			
V4 HASTA 4,90 ML		V14 HASTA 6,60 ML			
V5 HASTA 5,40 ML		V15 HASTA 6,90 ML			
V6 HASTA 5,80 ML		V16 HASTA 7,30 ML			
V7 HASTA 6,00 ML		V18 HASTA 7,80 ML			
V8 HASTA 6,30 ML		V19 HASTA 7,90 ML			
V9 HASTA 6,80 ML					
V10 HASTA 6,90 ML					
V11 HASTA 7,30 ML					
V13 HASTA 7,80 ML					
V14 HASTA 7,90 ML					

- SP.: SUELA DE POLIESTIRENO DE 3 CM AUMENTA.....0,55 €/ML
- D.C.: DOBLE CELOSÍA POR CORTANTE.....0,55 €/ML

* IVA NO INCLUIDO

oct-22

OFICINA: C/CARACAS, Nº10 (36203) VIGO – TFNOS. 986421617 / 986420560 FAX: 986483297
 ALMACEN VINCIOS: RUA OUTEIRO DO FERRO – POLIG. A PASAXE – VINCIOS (GONDOMAR) – TFNO: 986467001
 ALMACEN PONTEAREAS: LOMBA, 81 – AREAS (PONTEAREAS) – TFNO: 986640283
 Mail: info@cabadacomercial.com / tecnicos@cabadacomercial.com / ponteareas@cabadacomercial.com
 Web: www.cabadacomercial.com



TARIFA DE PRECIOS

VIGUETA ARMADA

ARTICULOS		PVP* (€/ML)
VIVIENDA		
30	V1 HASTA 3,00 ML	CONSULTAR
	V2 HASTA 3,50 ML	
	V3 HASTA 3,90 ML	
	V4 HASTA 4,00 ML	
	V5 HASTA 4,40 ML	
	V6 HASTA 4,70 ML	
	V7 HASTA 4,90 ML	
	V8 HASTA 5,20 ML	
	V9 HASTA 5,50 ML	
	V10 HASTA 5,60 ML	
	V11 HASTA 6,00 ML	
	V12 HASTA 6,05 ML	
	V13 HASTA 6,30 ML	
	V14 HASTA 6,60 ML	
	V15 HASTA 6,90 ML	
	V16 HASTA 7,30 ML	
	V17 HASTA 7,60 ML	
	V18 HASTA 7,90 ML	
	V19 HASTA 8,00 ML	

- S.P.: SUELA DE POLIESTIRENO DE 3 CM AUMENTA..... 0,55 €/ML
- D.C.: DOBLE CELOSIA POR CORTANTE..... 0,55 €/ML

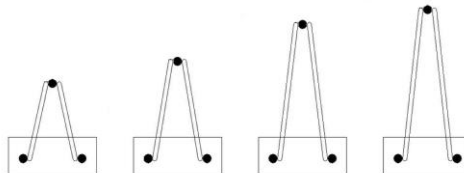
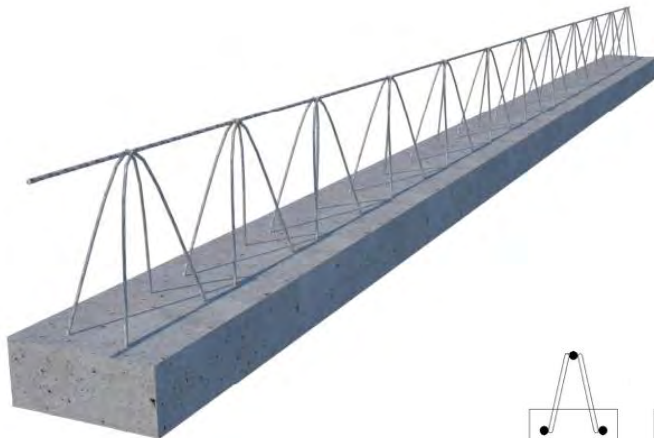

* IVA NO INCLUIDO

oct-22

OFICINA: C/CARACAS, Nº10 (36203) VIGO – TFNOS. 986421617 / 986420560 FAX: 986483297
 ALMACEN VINCOS: RUA OUTEIRO DO FERRO – POLIG. A PASAXE – VINCOS (GONDOMAR) – TFNO: 986467001
 ALMACEN PONTEAREAS: LOMBA, 81 – AREAS (PONTEAREAS) – TFNO: 986640283
 Mail: info@cabadacomercial.com / tecnicos@cabadacomercial.com / ponteareas@cabadacomercial.com
 Web: www.cabadacomercial.com



TARIFA DE PRECIOS

BOVEDILLA DE HORMIGÓN

CANTO	Dimensiones mm	Kg/ud	Ud/palet	PVP* (€/UD)
70/12 NUEVA	625x200x120	13	75	0,86
70/17	625x250x170	19	44	1,08
70/17 NUEVA	625x200x170	18	55	1,00
70/20 NUEVA	625x200x200	18	50	1,02
70/20 ABIERTA	625x250x200	21.5	40	1,09
70/20 CERRADA	625x250x200	21.5	40	1,14
70/25 ABIERTA	625x200x250	20	45	1,22
70/25 CERRADA	625x200x250	20	45	1,35
70/30	625x200x300	21.2	30	1,58



BOVEDILLA DE ARLITA

CANTO	Dimensiones mm	Kg/ud	Ud/palet	PVP* (€/UD)
70/12	625x250x110	9	60	1,60
70/17	625x250x165	11	44	1,90
70/20 ABIERTA	625x250x200	12.5	40	2,11
70/20 CERRADA	625x250x200	12.5	40	2,19
70/25 ABIERTA	625x220x250	12	36	2,21
70/25 CERRADA	625x220x250	12	36	2,30
PALET DE MADERA				14,00



BOVEDILLA DE POLIESTIRENO

TIPO	Densidad kg/m3	Dimensiones mm	CANTO	PVP* (€/UD)
P - I	9 - 10	125 X 625	20	8,27
		125 X 625	25	10,33
		100 X 625	30	9,92
P - III	13.5 - 15	100 X 625	15	6,97
		125 X 625	17	9,88
		125 X 625	20	11,62
		125 X 625	25	14,52
		100 X 625	30	13,94
P - IV	18 - 20	125 X 625	12	8,98
		100 X 625	15	8,98
		125 X 625	17	12,72
		125 X 625	20	14,97
		125 X 625	25	18,71



BOVEDILLA CERÁMICA

ARTÍCULO	UDS/ PALET	KG/UD	PVP (€/UD)
BOVEDILLA 70 X 25 X 14	70	10	CONSULTAR*
BOVEDILLA 70 X 25 X 20	50	11,80	CONSULTAR*
BOVEDILLA 70 X 25 X 25	40	14,30	CONSULTAR*
BOVEDILLA CERAMICA CURVA 13	620x240x127	Ud/m2:5,6	CONSULTAR*

*Hasta fin de existencias



* IVA NO INCLUIDO

mar-25

OFICINA: C/CARACAS, Nº10 (36203) VIGO – TFNOS. 986421617 / 986420560
 ALMACEN VINCOS: RUA OUTEIRO DO FERRO – POLIG. A PASAXE – VINCOS (GONDOMAR) – TFNO: 986467001
 ALMACEN PONTEAREAS: LOMBA, 81 – AREAS (PONTEAREAS) – TFNO: 986640283
 Mail: info@cabadacomercial.com / tecnicos@cabadacomercial.com / ponteareas@cabadacomercial.com
 Web: www.cabadacomercial.com



TARIFA DE PRECIOS

ARTICULOS	PVP* (€/UD)
SEPARADOR CONDOR	0,09
SEPARADOR TIMON	0,06
SEPARADOR HORMIGON	0,11
SEPARADOR UNIFOR PFI01 – HORMIGÓN	0,15
SEPARADOR UNIFOR PFI02 – POLIESTIRENO	0,18
SETA PROTECTORA ARMADURA	0,11



Condor



Timón



SEPARADOR UNIFOR PFI02 - POLIESTIRENO



REF.	MEDIDA mm				
	L	x	A	x	D
PFI02	85	x	60	x	17

- Corrugado de hasta 16 mm y placas poliestireno.

SEPARADOR UNIFOR - PFI01 - Hormigón



REF.	MEDIDA mm				
	L	x	A	x	D
PFI01	85	x	30	x	17

- Corrugado de hasta 16 mm.

* IVA NO INCLUIDO

ene-24

OFICINA: C/CARACAS, Nº10 (36203) VIGO – TFNOS. 986421617 / 986420560 FAX: 986483297
 ALMACEN VINCOS: RUA OUTEIRO DO FERRO – POLIG. A PASAXE – VINCOS (GONDOMAR) – TFNO: 986467001
 ALMACEN PONTEAREAS: LOMBA, 81 – AREAS (PONTEAREAS) – TFNO: 986640283
 Mail: info@cabadacomercial.com / tecnicos@cabadacomercial.com / ponteareas@cabadacomercial.com
 Web: www.cabadacomercial.com



TARIFA DE PRECIOS

VIGUETA PRETENSADA

ARTICULOS	PVP* €/ML
VIGUETAS T-11 LISAS PARA CUBIERTA (Medida cortadas rectas)	
VIGUETA T-11 HASTA 3,00	5,36
VIGUETA T-11 DESDE 3,05 HASTA 4,00	5,44
VIGUETA T-11 DESDE 4,05 HASTA 5,00	5,75
VIGUETA T-11 DESDE 5,05 HASTA 6,00	6,54
VIGUETA T-11 DESDE 6,05	7,25

ARTICULOS	PVP* €/ML
VIGUETAS T-14 LISAS	
VIGUETA T-14 HASTA 3,00	5,82
VIGUETA T-14 DESDE 3,05 HASTA 4,00	6,13
VIGUETA T-14 DESDE 4,05 HASTA 5,00	6,68
VIGUETA T-14 DESDE 5,05 HASTA 6,00	7,23
VIGUETA T-14 DESDE 6,05	7,39

T-11 LISA

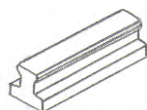

T-14



T-16

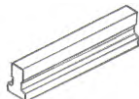

T-21

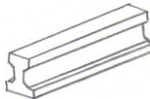

T-30

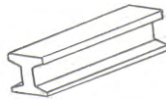

T-11 RUGOSAS

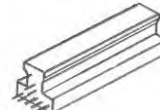

ARTICULOS	PVP* €/ML
VIGUETAS T-16 LISAS	
VIGUETA T-16 HASTA 3,00	6,42
VIGUETA T-16 DESDE 3,05 HASTA 4,00	6,82
VIGUETA T-16 DESDE 4,05 HASTA 5,00	7,37
VIGUETA T-16 DESDE 5,05 HASTA 6,00	7,76
VIGUETA T-16 DESDE 6,05	8,23
VIGUETA T-21 HASTA 8.50	13,84
VIGUETA T- 30	32,50

ARTICULOS	PVP* €/ML
VIGUETAS T-11 RUGOSAS PARA FORJADO (Medida contada con 8 cm de armadura a cada lado)	
VIGUETA T-11 HASTA 3,00	5,28
VIGUETA T-11 DESDE 3,05 HASTA 4,00	5,36
VIGUETA T-11 DESDE 4,05 HASTA 5,00	5,68
VIGUETA T-11 DESDE 5,05 HASTA 6,00	6,46
VIGUETA T-11 DESDE 6,05	7,17

PONTONES MADERA : 2,50 €/UD

(Se abonarán por el mismo importe a su devolución)

VIGUETAS PARA CUBIERTA intereje 1,2 m					
		LUCES MÁXIMAS DE UTILIZACION (m)			
		URALITA		URALITA+TEJA	
VIGUETA	MU (m KN)	SIMPLE	DOBLE	SIMPLE	DOBLE
T11-1	3.21	3.65	4.60	3.10	4.00
T11-2	3.45	3.80	4.80	3.20	4.15
T11-3	3.88	4.00	5.10	3.40	4.40
T11-5	4.32	4.25	5.35	3.60	4.60
T16-1	7.44	5.55	6.90	4.75	6.05
T16-2	8.44	5.90	7.35	5.05	6.45
T16-3	9.46	6.25	7.80	5.35	6.80
T21-1	16.91	7.90	9.65	6.80	8.50
T21-2	18.27	8.20	10.00	7.05	8.85
LUCES MÁXIMAS VIGUETAS T30 PARA ANCHOS DE BANDA DE 5 M CON CORREAS T16 SEPARADAS ENTRE SÍ 1,2 M (MAYORACIÓN 1,5)					
VIGUETA	MU (m KN)	ARMADO		URALITA	URALITA+TEJA
T30-1	44.52	5+0+1+1 = 7r6		6.35	5.50
T30-2	46.86	3+1+0+1 = 5r7		6.55	5.65
T30-3	52.22	5+0+1+1 = 7r7		6.90	5.95

POSTE RECTO Y DINTEL

ARTICULOS	PVP* €/ML
POSTE RECTO HASTA 4.00	4,86
DINTEL 10X8	4,67
DINTEL 14X8 HASTA 4 M	5,86
DINTEL 14X8 DESDE 4,25 M	6,17
<i>TANTO LOS POSTES RECTOS COMO LOS DINTELES SON CONSIDERADOS ELEMENTOS DE CIERRE, NO ESTANDO CONTEMPLADA SU UTILIZACION COMO CARGADEROS</i>	

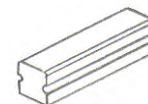

POSTE RECTO

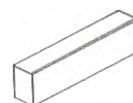

DINTEL

feb-25

* IVA NO INCLUIDO

OFICINA: C/CARACAS, N°10 (36203) VIGO – TFNOS. 986421617 / 986420560
 ALMACEN VINCIOS: RUA OUTEIRO DO FERRO – POLIG. A PASAXE – VINCIOS (GONDOMAR) – TFNO: 986467001
 ALMACEN PONTEAREAS: LOMBA, 81 – AREAS (PONTEAREAS) – TFNO: 986640283
 Mail: info@cabadacomercial.com / tecnicos@cabadacomercial.com / ponteareas@cabadacomercial.com
 Web: www.cabadacomercial.com



TARIFA DE PRECIOS

Postes

ARTICULOS		PVP*
POSTE BRAZO RECTO	280 X 150	25,35 €/UD
	250 X 130*	26,75 €/UD
POSTE BRAZO 1 PIE	250 X 150	25,35 €/UD
	250 X 180*	27,70 €/UD
POSTE CIERRE BRAZO 245X40		22,85 €/UD
POSTE 250X16X14		29,90 €/UD
POSTE PERGOLA	255 X 16 X 16	30,80 €/UD
	300 X 16 X 16	36,35 €/UD
POSTE CIERRE LISO	20 X 20 X 250	41,95 €/UD
	20 X 20 X 300	49,50 €/UD
	25 X 25 X 250	67,00 €/UD
POSTE CIERRE LISO REFORZADO	20 X 20 X 250	46,80 €/UD
	20 X 20 X 300	55,35 €/UD
	25 X 25 X 250	70,90 €/UD
PASTA CIERRE	300 X 100 X 0.07	82,00 €/UD
	300 X 120 X 0.07	96,40 €/UD
	170 X 120 X 0.07	54,50 €/UD
POSTE CIERRE ACANALADO	20 X 20 X 150	31,00 €/UD
	20 X 20 X 250	46,75 €/UD
	20 X 20 X 300	52,90 €/UD
	20 X 20 X 350	61,85 €/UD

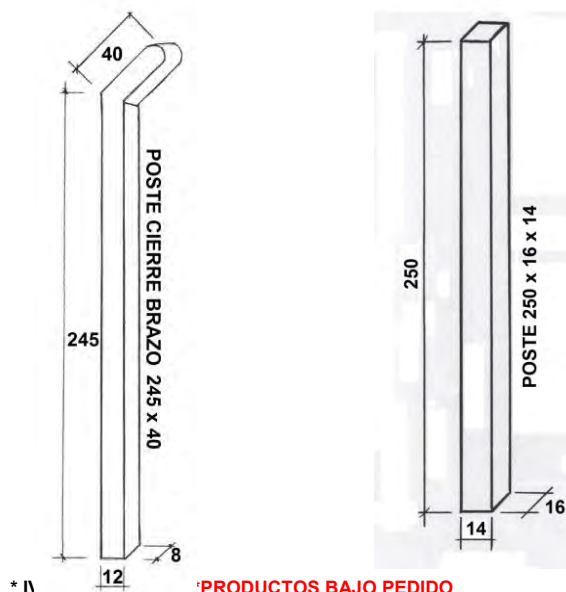
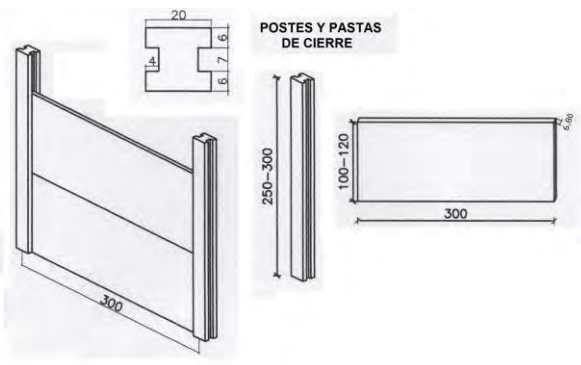
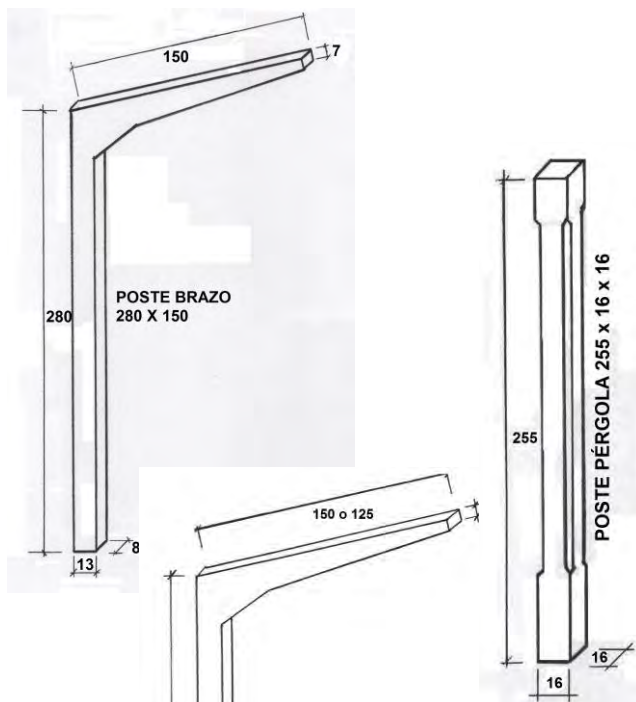

* PRODUCTOS BAJO PEDIDO
feb-25



TARIFA DE PRECIOS

Aros de Pozo

ARTICULOS (medidas exteriores)	PVP*
ARO DE POZO 120X50X7	44,85 €/UD
ARO DE POZO 150X33X7	46,15 €/UD
ARO DE POZO 180X33X7	47,15 €/UD

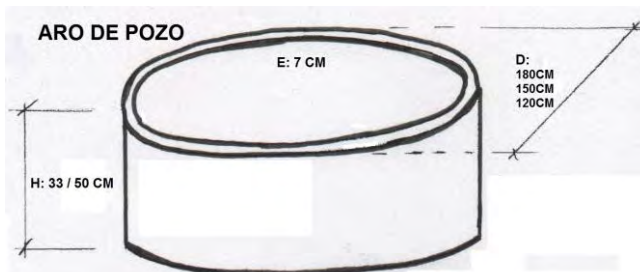

Tapas de Pozo

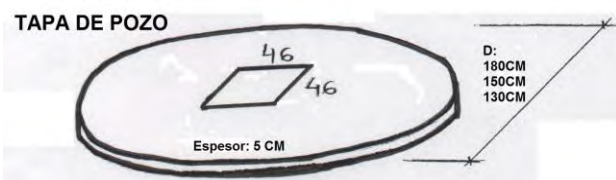

ARTICULOS (medidas exteriores)	PVP*
TAPA POZO 120X5	36,05 €/UD
TAPA POZO 130X5	36,05 €/UD
TAPA POZO 150X5	44,40 €/UD
TAPA POZO 180X5	62,10 €/UD
TAPA POZO REFORZADA 120	49,90 €/UD
TAPA POZO REFORZADA 130	49,90 €/UD
TAPA POZO REFORZADA 150	71,70 €/UD
TAPA POZO REFORZADA 180	96,00 €/UD

Tapas de Nicho

ARTICULOS	PVP*
TAPA NICH0 HORMIGÓN DE 64X69X3	11,00 €/UD
TAPA NICH0 HORMIGÓN DE 69X69X3	11,00 €/UD
TAPA NICH0 NEOPOR DE 59X69X3	11,15 €/UD
TAPA NICH0 NEOPOR DE 70X80X3	13,00 €/UD
TAPA NICH0 NEOPOR DE 70X90X3	19,50 €/UD

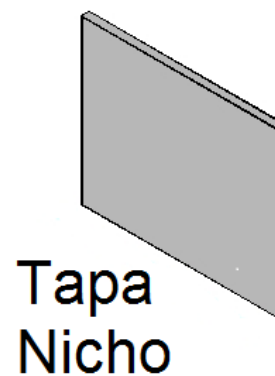

* IVA NO INCLUIDO

feb-25



TARIFA DE PRECIOS

BLOQUE DE CIERRE				
Dimensiones	Ud/palet	Kg/ud	Piezas/m2	PVP* (€/UD)
50 x 25 x 09	100	14	8	0,89
50 x 25 x 12	80	15	8	0,93
50 x 25 x 15	60	17.5	8	1,10
50 x 25 x 20	50	19	8	1,27



BLOQUE DE MURO				
Dimensiones	Ud/palet	Kg/ud	Piezas/m2	PVP* (€/UD)
50 x 20 x 20	50	18.5	10	1,29
50 x 20 x 25	40	20	10	1,37



BORDILLO JARDIN	
Dimensiones	PVP* (€/UD)
50 X 22 X 7 MACHIEMBRADO	2,08



PALET DE MADERA	14,00 €/UD
------------------------	-------------------

ARQUETA CEMENTO			
SIN FONDO		CON FONDO	
MEDIDA	PVP* (€/UD)	MEDIDA	PVP* (€/UD)
30X30X30	Consultar	30X30X30	Consultar
40X40X40	Consultar	40X40X40	Consultar
50X50X50	Consultar	50X50X50	Consultar
60X60X60	Consultar	60X60X60	Consultar
80X80X80	Consultar	80X80X80	Consultar
100X100X100	Consultar	100X100X100	Consultar



ARTÍCULO	PVP* (€/UD)
MARCO Y TAPA ARQUETA 30	Consultar
MARCO Y TAPA ARQUETA 40	Consultar
MARCO Y TAPA ARQUETA 50	Consultar
MARCO Y TAPA ARQUETA 60	Consultar
MARCO Y TAPA ARQUETA 80	Consultar
MARCO Y TAPA ARQUETA 100	Consultar

* IVA NO INCLUIDO

feb-25

OFICINA: C/CARACAS, Nº10 (36203) VIGO – TFNOS. 986421617 / 986420560 FAX: 986483297
 ALMACEN VINCOS: RUA OUTEIRO DO FERRO – POLIG. A PASAXE – VINCOS (GONDOMAR) – TFNO: 986467001
 ALMACEN PONTEAREAS: LOMBA, 81 – AREAS (PONTEAREAS) – TFNO: 986640283
 Mail: info@cabadacomercial.com / tecnicos@cabadacomercial.com / ponteareas@cabadacomercial.com
 Web: www.cabadacomercial.com



TARIFA DE PRECIOS

DEPURACIÓN DE AGUAS RESIDUALES (PREFABRICADOS DE HORMIGÓN)

ARTÍCULO	COTAS DE MONTAJE (CM)				PVP* (€/UD)
	Altura Total (HT)	Altura entrada (H)	Ø colector (Ø)	Ø máximo (D)	
DECANTADOR DIGESTOR					
ADD-100-1	230	195	15	117	CONSULTAR
ADD-100-2	280	245	15	117	CONSULTAR
ADD-100-3	330	295	15	117	CONSULTAR
ADD-125-1	225	195	15	143	CONSULTAR
ADD-125-2	275	245	15	143	CONSULTAR
ADD-125-3	325	295	15	143	CONSULTAR

ARTICULO	COTAS DE MONTAJE (CM)							PVP* (€/UD)
	Altura Total (HT)	Altura entrada (H)	Altura Relleno (HR)	Ø colector (Ø)	Diámetro			
					Tot DT	Ext DE	Int DI	
POZO FILTRANTE								
PF 100-1	125	90	60	15	117	109	100	CONSULTAR
PF 100-2	175	140	110	15	117	109	100	CONSULTAR
PF 100-3	225	190	160	15	117	109	100	CONSULTAR
PF 125-1	125	90	60	15	143	136	125	CONSULTAR
PF 125-2	175	140	110	15	143	136	125	CONSULTAR
PF 125-3	225	190	160	15	143	136	125	CONSULTAR

ARTICULO	COTAS DE MONTAJE (CM)						PVP* (€/UD)
	Altura Total HT	Altura entrada HE	Altura salida HS	Colector Ø	Medidas		
					Ext	Int	
SEPARADOR DE GRASA SG – 60X60X114							
	114	90	85	100	60	52	CONSULTAR

ARTICULO	COTAS DE MONTAJE (CM)								PVP* (€/UD)
	Altura			Ø colector (Ø)	Longitud		Anchura		
	Total HT	Entrada HE	Salida HS		Total LT	Int LI	Total AT	Int AI	
ARQUETA CON REJA DE DESBASTE									
AR-60X60X60-RD	60	SN	SN	SN	60	52	60	52	CONSULTAR
AR-80X80X80-RD	80	SN	SN	SN	80	70	80	70	CONSULTAR

(SN: SEGÚN NECESIDADES)

* IVA NO INCLUIDO

oct-22

OFICINA: C/CARACAS, Nº10 (36203) VIGO – TFNOS. 986421617 / 986420560 FAX: 986483297
 ALMACEN VINCIOS: RUA OUTEIRO DO FERRO – POLIG. A PASAXE – VINCIOS (GONDOMAR) – TFNO: 986467001
 ALMACEN PONTEAREAS: LOMBA, 81 – AREAS (PONTEAREAS) – TFNO: 986640283
 Mail: info@cabadacomercial.com / tecnicos@cabadacomercial.com / ponteareas@cabadacomercial.com
 Web: www.cabadacomercial.com



TARIFA DE PRECIOS

ARTÍCULO	PVP* €/UD)
FOSA SÉPTICA 140x100	CONSULTAR
FOSA SÉPTICA 230x140	CONSULTAR
ARO 80x50x4,5	CONSULTAR
ARO 100x50x4,5	CONSULTAR
ARO 125x50x5,5	CONSULTAR
ARO 150x50x6	CONSULTAR
ARO 200x40x7	CONSULTAR

ESQUEMA DE INSTALACIÓN CON DECANTADOR PRIMARIO Y POZO FILTRANTE

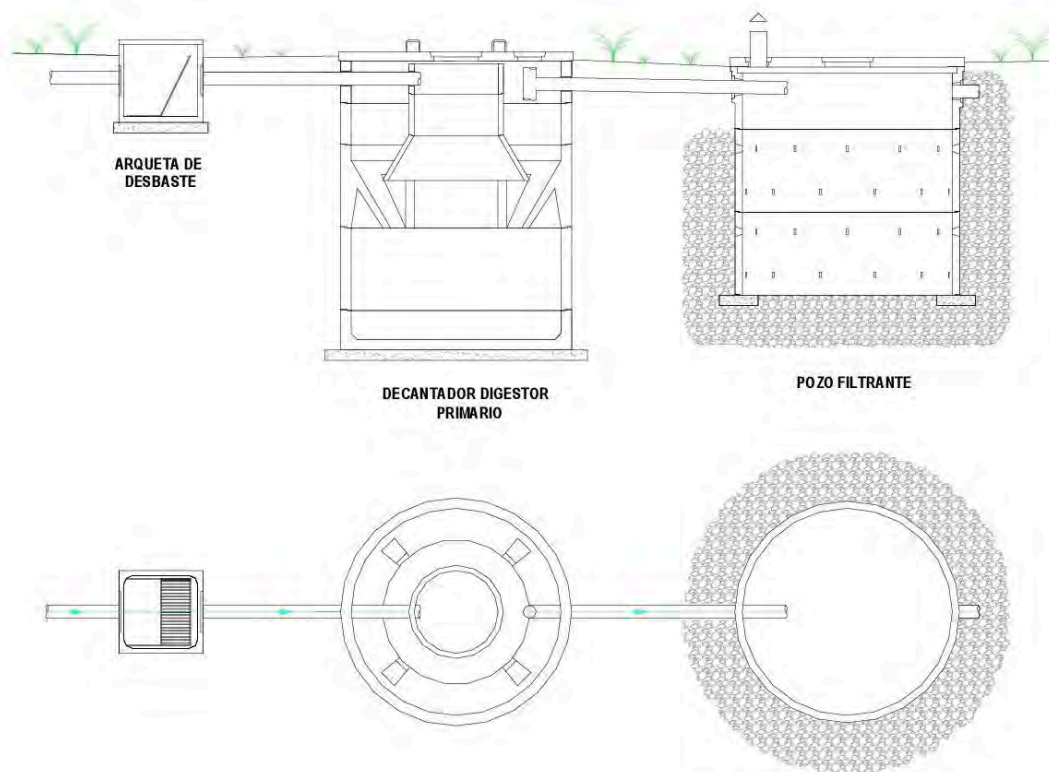

PRU HERDANZA S.L.	Facto	Nombre	DECANTADOR DIGESTOR 1º + POZO FILTRANTE	Escala
	DB.	G.I.S.S.		
	Comp.			
	Nombre			
	INSTALACION			Formato

* IVA NO INCLUIDO

oct-22



TARIFA DE PRECIOS

Poliestireno Extrusionado - CHOVAFOAM -

ARTICULO		PVP €/M3	PVP €/M2	PVP* (€/UD)
CÁMARA DE AIRE, FACHADAS Y SUELOS – ACABADO MACHIHEMBRADO				
81951A	250 H40 DE 2600X600X40	97,24	3.890	6.07
81952A	250 H50 DE 2600X600X50		4.862	7.58
81954A	250 H60 DE 2600X600X60		5.834	9.10
81955A	250 H80 DE 2600X600X80		7.779	12.14
CUBIERTA INVERTIDA – ACABADO MEDIA MADERA				
81910A	300 M40 DE 1250X600X40	97,24	3.890	2.92
81915A	300 M50 DE 1250X600X50		4.862	3.65
81920A	300 M60 DE 1250X600X60		5.834	4.38
81930A	300 M80 DE 1250X600X80		7.779	5.83
SUELOS – CORTE RECTO				
81961A	250 S40 DE 1250X600X40	97,24	3.890	2.92
81962A	250 S50 DE 1250X600X50		4.862	3.65
81963A	250 S60 DE 1250X600X60		5.834	4.38
CUBIERTA INCLINADA – MEDIA MADERA ACANALADO				
81980A	300 R40 DE 1250X600X40		A CONSULTAR	
81985A	300 R50 DE 1250X600X50			
81986A	300 R60 DE 1250X600X60			

ESPESOR XPS	UD/PQ
40 MM	9
50 MM	8
60 MM	7
80 MM	5
100 MM	4



EN VIGOR 15 DE FEBRERO DE 2025

* IVA NO INCLUIDO

feb-25

OFICINA: C/CARACAS, Nº10 (36203) VIGO – TFNOS. 986421617 / 986420560
 ALMACEN VINCIOS: RUA OUTEIRO DO FERRO – POLIG. A PASAXE – VINCIOS (GONDOMAR) – TFNO: 986467001
 ALMACEN PONTEAREAS: LOMBA, 81 – AREAS (PONTEAREAS) – TFNO: 986640283
 Mail: info@cabadacomercial.com / tecnicos@cabadacomercial.com / ponteareas@cabadacomercial.com
 Web: www.cabadacomercial.com



TARIFA DE PRECIOS



Lana Mineral

	REF.	Espesor mm	Ancho m	Largo m	Panel/Rollo	Ud/Pqte	M2/Pqte	€/m2	PVP* €/Paquete
APLICACIÓN: TABIQUES, MEDIANERAS Y TRASDOSADOS									
TERRA BASE	2140335	50	0.40	13.50	ROLLO	3	16.20	2,309	37,41
	2140340	75	0.40	8.10	ROLLO	3	9.72	3,816	37,10*
	2141651	50	0.60	1.35	PANEL	15	12.15	2.372	28,82
	2141653	75	0.60	1.35	PANEL	10	8.10	4,668	37,81
APLICACIÓN: MEDIANERAS Y TRASDOSADOS. FALSOS TECHOS									
TERRA PLUS 32	2141708	40	0.60	1.35	PANEL	15	12.15	5,656	68,72
	2141731	60	0.60	1.35	PANEL	10	8,10	8,402	68,05
APLICACIÓN: TRASDOSADOS									
TERRA MUR	2141740	50	0.60	1.35	PANEL	13	10.53	5,005	52,70
APLICACIÓN: SUELOS FLOTANTES									
TERRA SOL	2131765	20	0.60	1.20	PANEL	17	12.24	6,031	73,81*
APLICACIÓN: FACHADA VENTILADA. FALSOS TECHOS									
TERRA VENTO	2142653	50	0.60	1.35	PANEL	12	9.72	7,921	77,00
	2142695	100	0.60	1.35	PANEL	6	4,86	14,054	68,30
APLICACIÓN: FACHADA VENTILADA									
TERRA VENTO PLUS	2142700	50	0.60	1.35	PANEL	10	8.10	13,166	106,64
	2142701	60	0.60	1.35	PANEL	9	7.29	14,311	104,33
	2142705	80	0.60	1.35	PANEL	7	5.67	15,238	86,40
APLICACIÓN: AISLAMIENTO ENTRE TABIQUILLOS									
TERRA MANTA PAPEL	2143967	60	1.20	12.50	ROLLO	1	15.00	3,223	48,35
	2143966	80	1.20	11.00	ROLLO	1	13.20	3,986	52,62
	2143970	100	1.20	8.50	ROLLO	1	10.20	5,230	53,34
	2143969	120	1.20	6.50	ROLLO	1	7.80	6,243	48,69
APLICACIÓN: AISLAMIENTO EXTERIOR CONDUCTOS METÁLICOS DE CLIMATIZACION									
AIR MANTA ALU	2141026	50	1.20	16.50	ROLLO	1	19,80	5,242	103,80

* Precio hasta fin stock



REF.	DESCRIPCIÓN	PVP*
9081	ROCFLAM PANEL CHIMENEA 1000X600X30	12,70 €/UD



Lana de Roca

REF.	MEDIDA	UD/PQTE	M2	Aplicación	PVP*
PANEL SEMI-RIGIDO ALPHAROCK E225 D.70 KG					
3901	1.35M X 0.60M X 60MM	7	5.67	(Falso Techo, Fachada Ventilada, Trasdosados)	consultar

* IVA NO INCLUIDO

mar-25



TARIFA DE PRECIOS



Aislamiento Reflectivo



REF.	ARTICULO	Ancho M	Largo M	Espesor MM	M2	Aplicación	PVP*
POL1	ONE	1.20	40	4	48	Suelo	193.70 €/Rollo
PRF1	RF1	1.20	35		42		114,35 €/Rollo
SP02P	SUPER	1.20	40	4	48	Cubiertas y Paredes	205,37 €/Rollo
PRF2	RF2	1.20	35		42		130.69 €/Rollo
PB1	BIG	1.20	30	4	36	Paredes y Fachadas (cámara aire, cub. inclinadas, techos y F. ventiladas)	171.53 €/Rollo
PU2	ULTRA	1.20	20	16	24		256,71 €/Rollo
PRPT	RPT	0.60	2	4	20 Tiras	Cantos y Frentes Forjado	175,03 €/Pqte
PRPTT	RPT	0.60	2	4	Tira		8,75 €/Ud
PBLH	BLH-B	1.20	30	8	36	Bajo Losa Hormigón-Suelos-Forjados	203,04 €/Rollo
BLHF	BLH-F	1.20	30	8	36	Aislamiento de suelos, forjados y cubiertas planas	182,03 €/Rollo
PF	CINTA POLYFIX	75MM	50			Sellado de Juntas	7,29 €/Rollo
PCP	KIT CAJÓN PERSIANAS	0.25	1.20				10,48 €/Ud
P3L	POLYNUM 3L	1.20	40	10	48	Multicapa	CONSULTAR
P5L	POLYNUM 5L	1.20	30	20	36		CONSULTAR
P7L	POLYNUM 7L	1.20	20	30	24		CONSULTAR



ARTICULOS		PVP* (€/UD)
ARLITA LECA DUR BB (2-10 mm)	SACO 50 LT (20 sacos/m3)	9,80
	SACO 1.5 M3	240,75



ARTICULOS	PVP* (€/UD)
PERLITA EXPANDIDA – Saco 166 lt (6 sacos/m3) – aislamiento –	8,95



ENTRA EN VIGOR EL 1 de Febrero de 2024

* IVA NO INCLUIDO

may-24

OFICINA: C/CARACAS, N°10 (36203) VIGO – TFNOS. 986421617 / 986420560 / 667648061
 ALMACEN VINCOS: RUA OUTEIRO DO FERRO – POLIG. A PASAXE – VINCOS (GONDOMAR) – TFNO: 986467001
 ALMACEN PONTEAREAS: LOMBA, 81 – AREAS (PONTEAREAS) – TFNO: 986640283
 Mail: info@cabadacomercial.com / tecnicos@cabadacomercial.com / ponteareas@cabadacomercial.com
 Web: www.cabadacomercial.com



TARIFA DE PRECIOS

Poliestireno Expandido

PLANCHAS ESTÁNDAR – COLOR BLANCO					
Tipo	Densidad	Dimensiones (cm)	Ud/pqte	Conductividad (W/(m·K))	PVP* (€/UD)
III	13.5-15	250 X 100 X 001	40	0.038	2,00
		250 X 100 X 002	20		3,72
		250 X 100 X 003	14		5,58
		250 X 100 X 004	10		7,44
		250 X 100 X 005	8		9,30
IV	18-20	250 X 100 X 001	40	0.036	2,54
		250 X 100 X 002	20		4,79
		250 X 100 X 003	14		7,19
		250 X 100 X 004	10		9,58
		250 X 100 X 005	8		11,98

**Bovedillas
Poliestireno:
consultar
en pág. 26**

PLANCHAS ONDA – COLOR BLANCO						
Tipo	Densidad	Variedad	Dimensiones (cm)	Ud/pqte	Conductividad (W/(m·K))	PVP* (€/UD)
IV	18-20	NORMAL	250 x 097	8	0.036	15,17
		C/ENCAJE	250 x 105	8		16,42
		DOBLE	250 x 098 x 004	8		12,14
		DOBLE	250 x 098 x 005	8		15,17

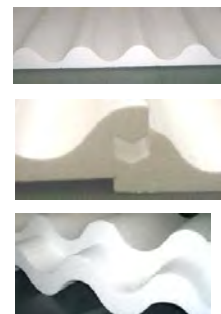

PLANCHAS PARA AISLAMIENTO TÉRMICO EXTERIOR - SATE -					
PLANCHA – COLOR BLANCO –			PLANCHA GRAFITADA (Gris oscuro)		
Tipo IV	Densidad: 18-20	Conductividad: 0.036	Tipo PN16	Densidad: 16	Conductividad: 0.032
Dimensiones (cm)	Ud/pqte	PVP* (€/UD)	Dimensiones (cm)	Ud/pqte	PVP* (€/UD)
100 X 050 X 001	100	0,47	100 X 050 X 001	100	0,54
100 X 050 X 002	50	0,94	100 X 050 X 002	50	1,07
100 X 050 X 003	34	1,42	100 X 050 X 003	34	1,61
100 X 050 X 004	24	1,89	100 X 050 X 004	24	2,15
100 X 050 X 005	20	2,36	100 X 050 X 005	20	2,68
100 X 050 X 006	16	2,83	100 X 050 X 006	16	3,22
100 X 050 X 007	14	3,30	100 X 050 X 007	14	3,75
100 X 050 X 008	12	3,78	100 X 050 X 008	12	4,29
100 X 050 X 010	10	4,72	100 X 050 X 010	10	5,36

OTROS PRODUCTOS DE EPS	
PERLA P-I (D.9-10) SACO 0.50 M3	31,46 €/UD
PERLA GRAFITADA (D.15-17) SACO 0.5 M3	62,21 €/UD
POLIESTIRENO MOLIDO EPS SACO 0.5 M3	17,16 €/UD



DOSIFICACIÓN PERLITA PARA HORMIGONERA DE 250 LT * mezclar durante 5 minutos *			
Densidad Hormigón	200 Kg/m3	250 Kg/m3	300 Kg/m3
Perlita	200 L	200 L	200 L
Cemento	40 Kg	50 Kg	60 Kg
Agua	20 L	25 L	30 L

* IVA NO INCLUIDO

oct-23



TARIFA DE PRECIOS

Resto accesorios SATE ver pag:53

ARTICULOS			PVP* (€/UD)
300620	MALLA ESPECIAL AISLANTE 160 GR – 1MX50M (50M2)	Color blanco / Realizada en fibra de vidrio Se utiliza en sistemas técnicos aislantes para evitar la formación de grietas en la fachada	44.33
ZIN331664E	ANGULO EN PVC CON RED	Con red de fibra de vidrio Se utiliza para que haya una resistencia uniforme en todo el aislamiento del edificio	1,50
ZIN331665E	ANGULO EN ALU CON RED		1,74



MALLA ESPECIAL AISLANTE

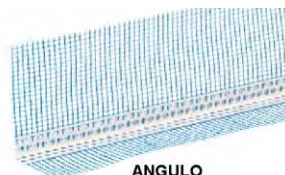

ANGULO

ARTICULOS			PVP* (€/UD)
981139	FIJADOR AISLAMIENTO 10X70	Fabricado en polipropileno Diámetro de roseta: 50 mm	0,09*
57611	FIJADOR AISLAMIENTO SPIT 10x95		0,25
60001	FIJADOR AISLAMIENTO SPIT 10x115		0,26
57630	FIJADOR AISLAMIENTO SPIT 10x135		0,37
TER112223	FIJADOR AISLAMIENTO 10x150		0,15*
TER112224	FIJADOR AISLAMIENTO 10x180		0,27*
FS8X70	FIJADOR SIMPLE 8X70	Fabricado en polipropileno Roseta: 60 mm Ø 6	0,10
2230	TACO PARA PANEL EXTRUSO 75X30MM	Fabricado en polipropileno Taco expansión con cabeza de 30mm Para anclajes de paneles aislantes	0,04*

* hasta fin existencias



FIJADOR AISLAMIENTO



FIJADOR SIMPLE



TACO PARA PANEL EXTRUSO

ARTICULOS			PVP* (€/UD)
PERFIL ARRANQUE GOTERÓN			
PA40G	40MMx2.5M	Fabricado en aluminio Base de salida con terminal anti-goteo Base para la colocación de los paneles aislantes en EPS, como primer paso del SATE	4,35
PARR50	50MMx2.5M		5,05
PA60G	60MMx2.5M		5,83
PARR8	80MMx2.5M		7,10
ZIN321678	50MMx2.5M	Perfil CLIP esquinero con red arranque, para mejorar goterón.	7,54

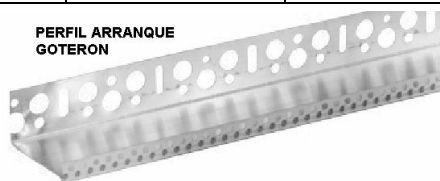

PERFIL ARRANQUE GOTERÓN

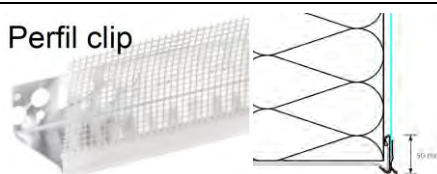

Perfil clip

* IVA NO INCLUIDO

nov-23



TARIFA DE PRECIOS



IMPERMEABILIZACIÓN BITUMINOSA

SBS- POLITABER Láminas de betún modificado

Código	Artículo	Armadura	M2/Rollo	PVP*
Polietileno / polietileno – No protegida				
31060	VEL 30	Fibra de Vidrio	12	42,73 €/Rollo
32150	POL PY 30	Filtro de Poliéster	12	51,82 €/Rollo
32155	POL PY 40		10	53,91 €/Rollo
37650	BANDA 33 (12x0.33)		12 ML	26,43 €/Rollo
37450	COMBI 40 – antiradón -	F. Poliéster Reforzado	10	51,34 €/Rollo
37444	COMBI 48 – antiradón -	F. Poliéster Reforzado	8	48,96 €/Rollo
Gránulo/ polietileno – Autoprottegida				
31319	VEL 40/G GRIS OSC	Fibra de Vidrio	10	42,47 €/Rollo
31400	VEL 40/G ROJO OSCURO			45,90 €/Rollo
37467	COMBI 40/G GRIS OSCURO	Filtro de Poliéster		54,05 €/Rollo
37462	COMBI 40/G ROJO OSC		59,35 €/Rollo	
37468	COMBI 50/G GRIS.OSC		8	50,79 €/Rollo
37464	COMBI 50/G ROJO OSC			56,63 €/Rollo
37480	COMBI GARDEN	F. Poliéster Reforzado	8	60,63 €/Rollo

APP- ChovAPLAST Láminas de betún aditivado

Código	Artículo	Armadura	M2/Rollo	PVP*
Polietileno – No protegida				
14001	VEL 30	Fibra de Vidrio	12	31,57 €/Rollo
14005	VEL 40		10	33,89 €/Rollo
Aluminio/ polietileno				
14060	ALU 30 NATURAL	Aluminio natural	12	56,63 €/Rollo

Código	Artículo	Aplicación	Presentación (m)	PVP*
CINTA AUTOADHESIVA – RAPID BRIC –				
60020	RAPID BRIC C10 NATURAL		12 x 0.10	13,38 €/Rollo
60030	RAPID BRIC C15 NATURAL		12 x 0.15	17,85 €/Rollo
60060	RAPID BRIC C30 NATURAL		12 x 0.30	32,26 €/Rollo
60310	RAPID BRIC C10 ROJO		12 x 0.15	16,47 €/Rollo
60320	RAPID BRIC C15 ROJO		12 x 0.15	24,54 €/Rollo
60330	RAPID BRIC C30 ROJO		12 x 0.30	42,56 €/Rollo

Código	Artículo	Aplicación	Presentación (m)	PVP*
POLITABER AUTOADHESIVA ANTIRADON				
60079	POLITABER NATURAL		20 x 1.00	95,24 €/Rollo

* IVA NO INCLUIDO

ene-25



TARIFA DE PRECIOS

IMPERMEABILIZACIÓN BITUMINOSA

PLACAS BITUMINOSAS

TEGOLA AMERICANA



Código	Artículo	Armadura	Presentación	PVP*
43006	TEGOLA STANDARD NEGRO (NUEVA)	Fibra de vidrio	3,05 M2	39,56 €/Pqte
43016	TEGOLA STANDARD VERDE (NUEVA)	Fibra de vidrio	3,05 M2	39,56 €/Pqte
43106	TEGOLA CASTOR NEGRO (NUEVA)	Fibra de vidrio	3,05 M2	41,96 €/Pqte
43116	TEGOLA CASTOR VERDE (NUEVA)	Fibra de vidrio	3,05 M2	41,96 €/Pqte

***BAJO PEDIDO**

IMPRIMACIONES Y EMULSIONES

Código	Artículo	Presentación	PVP*
55025E	SUPERMUL 25	25 KG	43,26 €/UD
55125	SUPERELAST 25	25 KG	64,35 €/UD
55721	PRIMER EAL 25	25 KG	58,63 €/UD



SLURRYS TRADICIONALES

Código	Artículo	Presentación	PVP*
84825	ASFALT SL NEGRO	50 KG	39,33 €/UD
84822	ASFALT RAPID NEGRO 25KG	25 KG	15,37 €/UD



ACCESORIOS PARA LA IMPERMEABILIZACIÓN

Código	Artículo	Presentación	PVP*
84020	CAZOLETA NORMAL EDPM 90		9,31 €/UD
84080	CAZOLETA LATERAL		20,48 €/UD
84090	PARAGRAVILLAS		1,80 €/UD
86035	GRANULO MINERAL ROJO OSC	25 KG	14,66 €/UD



* IVA NO INCLUIDO

ene-25

OFICINA: C/CARACAS, N°10 (36203) VIGO – TFNOS. 986421617 / 986420560

ALMACEN VINCOS: RUA OUTEIRO DO FERRO – POLIG. A PASAXE – VINCOS (GONDOMAR) – TFNO: 986467001

ALMACEN PONTEAREAS: LOMBA, 81 – AREAS (PONTEAREAS) – TFNO: 986640283

Mail: info@cabadacomercial.com / tecnicos@cabadacomercial.com / ponteareas@cabadacomercial.com

Web: www.cabadacomercial.com



TARIFA DE PRECIOS



IMPERMEABILIZACIÓN LIQUIDA

REVESTIMIENTOS IMPERMEABILIZANTES

Código	Artículo	PVP*
75261	CHOVATEC ANTIG. FIBRATADO ROJO 20 KG	55,48 €/UD
75262	CHOVATEC ANTIG. FIBRATADO GRIS 20 KG	
75263	CHOVATEC ANTIG. FIBRATADO BLANCO 20 KG	
75256	CHOVATEC ANTIG. FIBRATADO ROJO 5 KG	15,80 €/UD
75257	CHOVATEC ANTIG. FIBRATADO GRIS 5 KG	
75258	CHOVATEC ANTIG. FIBRATADO BLANCO 5 KG	



ARMADURAS Y BANDAS DE REFUERZO

Código	Artículo	Presentación	PVP*
82220	MALLA 50 DE REFUERZO (Fibra de vidrio) 55 gr/m2	50x1	45,05 €/UD

DRENAJES Y GEOTEXILES

LÁMINAS DRENANTES

Código	Artículo	Presentación	PVP*
83164	CHOVADREN	2X30	90,95 €/UD
83175	CHOVADREN DD (con geotextil)	2x20	147,00 €/UD
83179	CHOVADREN 20 GARDEN	2X20	303,73 €/UD
83180	ROSETA Y CLAVOS CHOVADREN	200 UD	42,37 €/CAJA



GEOTEXILES

Código	Artículo	Peso (g/m2)	Presentación (m)	PVP*
83253	GEOFIM PP 125 – 15	125	1.83 X 100	217,20 €/UD
83257	GEOFIM PP 200 – 23	200		363,75 €/UD



ChovATERM

LÁMINA IMPERMEABILIZANTE CON POLIESTIRENO EXTRUIDO



Código	Artículo	Espesor	PVP*
35002	XPS 40 COMBI 50/G GRIS O	40 mm	136,77 €/UD
34996	XPS-50 POL PY 30 5X1	50 mm	111,11 €/UD

* IVA NO INCLUIDO

ene-25



TARIFA DE PRECIOS



IMPERMEABILIZANTES LÍQUIDOS

Código	Artículo	Peso	Color	PVP*
75200E	CHOVASTAR PREPARADOR SUPERFICIES	4 KG	NEGRO	16,24 €/UD
78301	CHOVASTAR COLA AISLAMIENTOS Instalación de mat. Multicapa y aislantes fibrosos (CHOVACUSTIC, CHOVAPREN)	5 LT		28,60 €/UD
58100	CHOVASTAR COLA AISLAMIENTOS Instalación de mat. Multicapa y aislantes fibrosos (CHOVACUSTIC, CHOVAPREN)	20 LT		99,24 €/UD



* IVA NO INCLUIDO

ene-25



TARIFA DE PRECIOS



IMPERMEABILIZACIÓN Y AISLAMIENTO

AISLAMIENTO ACÚSTICO A RUIDO AÉREO

LÁMINAS VISCOELÁSTICAS DE ALTA DENSIDAD

Código	Artículo	Espesor	Dimensiones	PVP*
56002	VISCOLAM 65	4 mm	5.5 x 1	31,22 €/UD
56005	VISCOLAM Autoadhesiva Plancha	4 mm	1.2 x 1	10,04 €/UD
56007	VISCOLAM Autoadhesiva Rollo	4 mm	5.5 x 1	43,10 €/UD



COMPUESTOS Y PANEL MULTICAPA

Código	Artículo	Espesor	Dimensiones	PVP*
56003	PANEL CHOVACUSTIC 65 LR 70/4	44 mm	1 x 0.60	14,77 €/UD
56304	CHOVACUSTIC 35 FIELTEX	18 mm	5.5 x 1	49,39 €/UD
56303	CHOVACUSTIC 65 FIELTEX	20 mm	5.5 x 1	64,41 €/UD
58185	ELASTOBAND BAJANTES (altura: 420 mm x longitud 10 m)			50,77 €/UD
58130	BANDA DESOLARIZANTE 100	4 mm	5,5 M x 100 mm	5,90 €/UD

AGLOMERADOS

Código	Artículo	Espesor	Dimensiones	PVP*
81615	CHOVAPREN 80/4 (P.multiaislante)	40 mm	2 x 1	17,88 €/UD
81617	CHOVAPREN 110/2 (P.multiaislante)	20 mm	2 x 1	13,36 €/UD



PANEL ABSORBENTE

Código	Artículo	Dimensiones (placa)	PVP*
81551	CHOVACUSTIC DECO MARINA (paquete de 10 placas)	500 x 500 x 30	29,42 €/paquete
81552	CHOVACUSTIC DECO PIRÁMIDE (paquete de 8 placas)	450 x 450 x 43	28,38 €/paquete

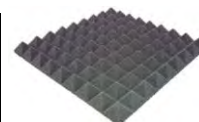

AISLAMIENTO ACÚSTICO A RUIDO DE IMPACTO

Código	Artículo	Dimensión (m)	PVP*
82450	CHOVAIMPACT 3 mm	150 x 1.5	112,61 €/UD
82460	CHOVAIMPACT 5 mm	100 x 1.5	113,69 €/UD
82465	CHOVAIMPACT 10 mm	42 x 1.2	111,54 €/UD
58050	CHOVAIMPACT PLUS 9 mm	45 x 1.5	261,58 €/UD



* IVA NO INCLUIDO

ene-25



TARIFA DE PRECIOS



		KG	UD/P	APLICACIÓN	PVP* (€/ud)	
MP	MAX PLUS	20	60	Escayola-perlita Aplicación manual	4,72	
PEM	PERLISCAYOLA MANUAL	20	60		4,95	
MAF10	MAX FINO	10	60	Yeso especial de terminación en base escayola que proporciona un acabado fino y fácil lijado aplicado sobre los yesos.	3,45	
MAF17		17	64		4,48	
YG	YESO RAPIDO	20	64	Yeso manual para guarnecidos int (paredes, techos), ligante de ladrillos en tabiquería int y recibido de elementos como marcos, caja de luz, ...	3,57	
YC5	YESO COLA	5	105	Pegamento moldura	2,95	
YC10		10	120		3,75	
YC25		25	48		8,85	
ESC17	ESCAYOLA ESYEDEBRO	17	64	Escayola - nuevo envase	2,78	
GT	GOTELIS	15	72	Alisado paredes – GOTELÉ	10,05	
UM6	UNI MAX	6		Puente unión yeso	22,40	
HC	HIDRÓXIDO DE CAL	20	50		7,70	
PJ1H	PASTA JUNTAS ESYEDEBRO	1 H	20	Pasta juntas para PLADUR	12,97	
PJ2H		2 H	10		120	7,25
PJ4H		4 H	25		48	16,30
PJ30		30 MÍN	10		120	7,25
PALP	PALETS DE MADERA (se abonarán por el mismo importe a su devolución)				12,00	



		Kg	Ud/P	Aplicación	PVP* (€/ud)
	RUBÍ	25	48	Yeso aligerado con perlita B4 (YMP/A).	5,20
	PLATINUM	20	60	Yeso aligerado altas prestaciones aligerado con perlita	5,57
	CORAL+	20	64	Yeso monocapa mecánica sin aligerar	3,90
Manual	JADE	20	64	Yeso fraguado RAPIDO / Albañilería y pequeñas reparaciones	3,25
	PERLA	17	72	Yeso aligerado con perlita (altas prestaciones) Guarnecido de tabiques y techos en int.	3,45
	DIAMANTE	20	64	Yeso ALTA DUREZA (altas prestaciones) Guarnecido de tabiques y techos en int. Indicado para edificios con alto tránsito (colegios, hospitales, restaurantes)	3,90
Fino	AMATISTA	20	64	Yeso de terminación, de aplicación manual	7,20
	AMATISTA PLUS	20	64	Yeso FINO de ACABADO para yesos manuales. Terminación trabajos realizados con yesos de proyección.	8,65
Masillas	CRISTAL TOTAL	15	40	Masilla de fraguado rápido para cubrir gota o renovar superficies con relieve. De muy fácil lijado. Un solo producto para nivelar y terminar, dejando el soporte listo para pintar.	13,10
	CRISTAL EXTRAFINISH	15	40	Extrafina para preparar la superficies antes de pintar o para el acabado de tabiques y techos tratados con otros productos cuando se requieran acabados de gran calidad y finura.	13,92
	CRISTAL READY	20	33	Lista al uso indicada para realizar pequeñas renovaciones, alisar, reparar pequeñas irregularidades y en general para preparar soportes antes de pintar	25,60
Cola	AMBAR	20	64	Cola especial para el montaje de tabiques cerámicos de gran formato y pegado de otros materiales de construcción.	6,10



ARTICULOS		PVP* (€/ud)
710001	MALLA FIBRA DE VIDRIO 75 GR. DE 1X50 50M2 (YESO)	30.32
300620	MALLA ESPECIAL AISLANTE 160 GR DE 1X50 50M2	44.33

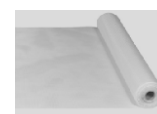

* IVA NO INCLUIDO

abr-24

OFICINA: C/CARACAS, N°10 (36203) VIGO – TFNOS. 986421617 / 986420560
 ALMACEN VINCIOS: RUA OUTEIRO DO FERRO – POLIG. A PASAXE – VINCIOS (GONDOMAR) – TFNO: 986467001
 ALMACEN PONTEAREAS: LOMBA, 81 – AREAS (PONTEAREAS) – TFNO: 986640283
 Mail: info@cabadacomercial.com / tecnicos@cabadacomercial.com / ponteareas@cabadacomercial.com
 Web: www.cabadacomercial.com



TARIFA DE PRECIOS

ARTICULOS	PVP* (€/UD)
PLANCHA LISA ESCAYOLA 100X60	1,84
BALDA ESTANTERIA 1200X300X40 MM	8,16
BALDA ESTANTERIA 1200X400X40 MM	10,78
BALDA ESTANTERIA 1200X500X40 MM	13,38

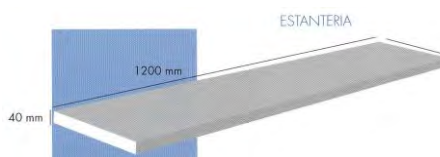

ARTICULOS	PVP* (€/UD)
M103-MOLDURA DE 65X45X1000	0,74
M104-MOLDURA DE 57X38X1000	0,74
M105-MOLDURA DE 60X40X1000	0,77
M201-MOLDURA DE 73X57X1000	0,95
M205-MOLDURA DE 80X50X1000	0,79
M206-MOLDURA ESCALONADA GRANDE 90X54X1200	1,38



ARTICULOS	PVP* (€/M2)	
TECHO DESMONTABLE 600X600	DECOTECH (Capri, Sol, Fisurado)	4,09
	PERFORADO	13,92
	SEMIPERFORADO	5,88
	PERFORADO ACÚSTICO	13,92



ARTICULOS	PVP* (€/UD)
ESPARTO MEZCLA ROLLO PEQUEÑO	7,00
ESPARTO SISAL BLANCO	15,45



PALET DE MADERA	12,00 €/UD
-----------------	------------

* IVA NO INCLUIDO

jun-24

OFICINA: C/CARACAS, Nº10 (36203) VIGO – TFNOS. 986421617 / 986420560
 ALMACEN VINCIOS: RUA OUTEIRO DO FERRO – POLIG. A PASAXE – VINCIOS (GONDOMAR) – TFNO: 986467001
 ALMACEN PONTEAREAS: LOMBA, 81 – AREAS (PONTEAREAS) – TFNO: 986640283
 Mail: info@cabadacomercial.com / tecnicos@cabadacomercial.com / ponteareas@cabadacomercial.com
 Web: www.cabadacomercial.com



TARIFA DE PRECIOS

ARTICULOS			PVP* (€/UD)
PAVIMENTOS – NIVELACIÓN DE SUELOS			
NIVELANTE 10 (gris)	25 KG	Pasta niveladora de fraguado rápido, reforzada con fibras	19,84
NIVELANTE 80 (gris claro)	25 KG	Para grandes recrecidos no estructurales	12,48
BETOLEVEL 15 (gris)	25 KG	De recrecido y excelente dureza	25,67
BETOCRIL	5 LT	Recubrimiento o imprimación de soportes cementosos de hormigón o mortero	50,44
PAVIMENTOS - IMPRIMACIONES			
PROPAM GRIP +	5 KG	Imprimación promotora de adherencias universal, lista al uso	35,56
	15 KG		101,35
COLOCACIÓN DE CERÁMICA – ADHESIVOS INTERIORES –			
VAT BLANCO	5 KG	Interior básico Cemento cola para fijación cerámica y gres	3,86
VAT GRIS	25 KG		4,15
VAT BLANCO	25 KG		4,83
COLOCACIÓN DE CERÁMICA – ADHESIVOS EXTERIORES –			
VAT SUPER GRIS	25 KG	Cemento cola para colocación de cerámica de absorción media en pavimentos y revest. int. y pav. ext.	6,27
VAT SUPER BLANCO	25 KG		6,82
VAT EXTRA GRIS	25 KG	Altas prestaciones	7,94
VAT EXTRA BLANCO	25 KG	Para Piscinas y Pladur	8,90
VAT PORCELÁNICO FLEXIBLE BLANCO	5 KG	Fijación gres porcelánico y piezas sin absorción	5,03
COLOCACIÓN DE CERÁMICA – ADHESIVOS ALTA FLEXIBILIDAD –			
VAT FLEX RAPID BLANCO	25 KG	Adhesivo deformable para colocación mármol y piedra natural , sin aparición de eflorescencias.	26,79
COLOCACIÓN DE CERÁMICA – ADHESIVOS SERIE ECOLÓGICA SIN POLVO –			
PAM ECOGEL PORCEL BLANCO	25 KG	Colocación de baldosas en paredes, suelos int y ext.	10,97
PAM ECOGEL PORCEL GRIS	25 KG		10,81
PAM ECOGEL FLEX BLANCO	25 KG	Flexible y deformable con elevado contenido en resinas	16,25
PAM ECOGEL FLEX GRIS	25 KG		15,37
COLOCACIÓN CERÁMICA – JUNTAS BASE CEMENTO–			
BORADA PORCELANICA CARTA COLORES	5 KG	Int y ext. hasta 4 mm	5,22
BORADA PORCELÁNICA BCO POLAR	4.5 KG	Int y ext. hasta 4 mm	5,11
BORADA UNIVERSAL CARTA COLORES	5 KG	Int y ext. 1-15 mm	5,22
BORADA CHROMA BLANCO	3 KG	Inte y ex hasta 8 mm- EFECTO GOTA. Antimoho, flexible, especial gran formato.	6,75
BORADA CHROMA Antracita-negro-wengue-tundra-zafiro	3 KG		9,39
BORADA CHROMA COLORES	3 KG		8,41
COLOCACIÓN CERÁMICA – JUNTAS BASE EPOXI –			
BORADA EPOLUXE	3 KG	Mortero epoxi decorativo de fácil limpieza, para sellado antiácido de juntas hasta 20 mm	46,04
COLOCACIÓN CERÁMICA – JUNTAS RESINA			
BORALASTIC	2 LT	ADITIVO PARA BORADAS	15,96
REVESTIMIENTOS DE CAL – MORTEROS DE CAL			
REVAT CAL MURO – gris –	25 KG	Mortero de albañilería y recuperación de fábricas en base cal	8,55
REVAT CAL FONDO –gris –	25 KG	Mortero de revestimiento en base cal	8,64
REVAT CAL BASE – blanco o gris –	25 KG		13,80
REVAT CAL ENFOSCADO – colores –	25 KG	Mortero hidrófugo de revoco en base cal	9,86
REVAT CAL ESTUCO – blanco –	25 KG	Estuco fino de cal - acabado fratasado	62,36
REVAT CAL FINO – blanco –	3 KG	Estuco fino de cal – acabados mate o brillante –	14,66
ADHESIVO PIEDRA			
ADHESIVO PIEDRA BLANCO	25 KG	Adhesivo específico para colocación de piedra y sus derivados	14,35



* IVA NO INCLUIDO

feb-25

OFICINA: C/CARACAS, Nº10 (36203) VIGO – TFNOS. 986421617 / 986420560
 ALMACEN VINCIOS: RUA OUTEIRO DO FERRO – POLIG. A PASAXE – VINCIOS (GONDOMAR) – TFNO: 986467001
 ALMACEN PONTEAREAS: LOMBA, 81 – AREAS (PONTEAREAS) – TFNO: 986640283
 Mail: info@cabadacomercial.com / tecnicos@cabadacomercial.com / ponteareas@cabadacomercial.com
 Web: www.cabadacomercial.com



TARIFA DE PRECIOS

ARTICULOS			PVP* (€/UD)
REVESTIMIENTOS DE FACHADA – MORTERO MONOCAPA			
RE VAT PIEDRA	25 KG	CARTA COLORES	11,76
RE VAT RASPADO	25 KG	CARTA COLORES	12,16
REVESTIMIENTOS DE FACHADA – MORTERO REVOCO			
PROPAM REVOCO GRIS	25 KG	Revest. Int y ext.. Aplicación Manual y máquina	4,12
PROPAM REVOCO BLANCO	25 KG		4,68
PROPAM RENOVACIÓN	25 KG	Mortero hidráulico que actúa de recubrimiento para reparar fachadas	22,96
REVESTIMIENTOS DE FACHADA – CONSOLIDANTE			
PROPAM DUR	5 LT	Consolidante endurecedor	66,88
REVESTIMIENTOS DE FACHADA – HIDROFUGOS			
RE VAT PROTEC ORG / ACU	5 LT	Líquido hidro-repelente y protector de base orgánica (ORG) o base agua (ACU)	56,33
RE VAT PROTEC ORG / ACU	25 LT		208,75
REVESTIMIENTOS DE FACHADA – PRODUCTOS COMPLEMENTARIOS			
GRANITO PEQUEÑO	30 KG	COLORES	9,34
AISLAMIENTO TÉRMICO – MORTERO ADHESIVO Y DE PROTECCIÓN			
PROPAM AISTERM GRIS	25 KG	Mortero adhesivo hidrófugo. Colocación y protecc. placas poliestireno	14,76
PROPAM AISTERM BLANCO	25 KG		15,73
AISLAMIENTO TÉRMICO – MORTERO ACRÍLICO PROPAM COAT			
COAT PLAS - expt UF,SLX,SLX UF Y ESP	20 KG	Mortero acrílico fachadas e int.	58,92
COAT FILM - excepto RUBI y ESP-	20 KG	Mortero sintético fachadas e int (imprimación)	65,70
MORTEROS DE ALBAÑILERIA			
MORTERO SILICEO M 7.5 BLANCO	25 KG	Colocación de ladrillo y bloque	4,90
REPARACIÓN Y PROTECCIÓN DEL HORMIGÓN - REPARACIÓN			
PROPAM REPAR TECHNO GRIS	5 KG	Mortero de fraguado rápido y retracción compensada para la reparación estructural y enlucido del hormigón hierro visto.	10,65
PROPAM REPAR TECHNO GRIS	25 KG		36,17
PROPAM REPAR TECHNO 20 GRIS	25 KG	Restauración y enlucido estético del hormigón no estructural con hierro visto, fachadas, balcones etc	16,46
PROPAM REPAR 40 GRIS	25 KG	Mortero de reparación de estructuras de hormigón	24,93
PROPAM FAST	25 KG	Mortero de endurecimiento ultra rápido	26,36
REPARACIÓN Y PROTECCIÓN DEL HORMIGÓN – PUENTE DE UNIÓN			
BETOPOX 93	2 KG	Puente unión epoxi de baja viscosidad para hormigones y morteros	46,18
SISTEMA DE IMPERMEABILIZACION - REVESTIMIENTOS CEMENTOSOS			
PROPAM IMPE GRIS	25 KG	Recubrimiento para impermeabilización de superficies	29,79
PROPAM IMPE BLANCO	25 KG		31,20
PROPAM IMPE BLANCO	5 KG		11,74
PROPAM IMPE FLEX GRIS	15 KG	Impermeabilización int y ext de hormigón y albañilería (sótanos, terrazas...)	62,79
SISTEMA DE IMPERMEABILIZACION - REVESTIMIENTOS ACRÍLICOS			
PROPAM IMPELASTIC	5 KG	Membrana líquida elástica y flexible, lista al uso, de secado rápido para la impermeabilización de superficies interiores y exteriores	43,64
	15 KG		122,30
MORTEROS TÉCNICOS - REJUNTADO			
PROPAM BLOCK (BLANCO Y GRIS)	25 KG	Mortero hidrófugo coloreado para encintado	4,80
PROPAM BLOCK (resto colores)	25 KG		5,91
MORTEROS TÉCNICOS – REFRACTARIO			
PROPAM REFRACTARIO GRIS	5 KG	Colocación ladrillo refractario. Int y ext.	12,34
	25 KG		23,96
MORTEROS TÉCNICOS – PRODUCTOS COMPLEMENTARIOS			
DESINCRUSTANTE DE CEMENTO	1 LT	.	4,93



* IVA NO INCLUIDO

OFICINA: C/CARACAS, Nº10 (36203) VIGO – TFNOS. 986421617 / 986420560

ALMACEN VINCIOS: RUA OUTEIRO DO FERRO – POLIG. A PASAXE – VINCIOS (GONDOMAR) – TFNO: 986467001

ALMACEN PONTEAREAS: LOMBA, 81 – AREAS (PONTEAREAS) – TFNO: 986640283

Mail: info@cabadacomercial.com / tecnicos@cabadacomercial.com / ponteareas@cabadacomercial.com

Web: www.cabadacomercial.com

ene-25



TARIFA DE PRECIOS



CODIGO	DESCRIPCIÓN	PVP* (€/UD)
ARQUETA		
1372STAR	ARQUETA SIMPLE DE 200X200	3.65
1373STAR	ARQUETA SIMPLE DE 300X300	6.91
1374STAR	ARQUETA SIMPLE DE 400X400	15.84
1371STAR	ARQUETA SIMPLE DE 550X550	31.40
REJILLA ARQUETA DE PP REFORZADA		
1347	REJILLA ARQUETA DE 200X200	2.97
1357	REJILLA ARQUETA DE 300X300	7.55
1367	REJILLA ARQUETA DE 400X400	13.90
1377A	REJILLA ARQUETA DE 550X550	30.93
MARCO REFORZADO		
1395STAR	MARCO REFORZADO DE PP DE 200X200	1.57
1396STAR	MARCO REFORZADO DE PP DE 300X300	1.90
1397STAR	MARCO REFORZADO DE PP DE 400X400	3.79
1398STAR	MARCO REFORZADO DE PP DE 550X550	6.55
TAPADERA REFORZADA		
1348STAR	TAPADERA REFORZADA DE PP DE 200X200	2.14
1358STAR	TAPADERA REFORZADA DE PP DE 300X300	4.69
1368STAR	TAPADERA REFORZADA DE PP DE 400X400	11.13
1378STAR	TAPADERA REFORZADA DE PP DE 550X550	28.49

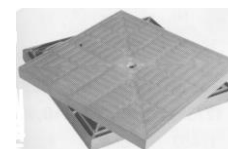
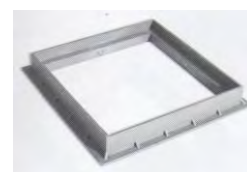
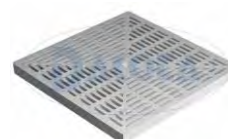

CODIGO	DESCRIPCIÓN	PVP* (€/UD)
TAPADERA REBAJADA		
POZ086857S	TAPADERA REBAJADA DE PP DE 300X300	7.28
POZ086858S	TAPADERA REBAJADA DE PP DE 400X400	12.42
PROLONGACIÓN		
POZ051376	PROLONGACIÓN ARQUETA H10 300X300	6,93
PLACA SIFÓNICA		
POZ061379	PLACA SIFÓNICA DE 300X300	2,33
POZ061380	PLACA SIFÓNICA DE 400X400	3.98



* IVA NO INCLUIDO

ene-24

OFICINA: C/CARACAS, Nº10 (36203) VIGO – TFNOS. 986421617 / 986420560
 ALMACEN VINCIOS: RUA OUTEIRO DO FERRO – POLIG. A PASAXE – VINCIOS (GONDOMAR) – TFNO: 986467001
 ALMACEN PONTEAREAS: LOMBA, 81 – AREAS (PONTEAREAS) – TFNO: 986640283
 Mail: info@cabadacomercial.com / tecnicos@cabadacomercial.com / ponteareas@cabadacomercial.com
 Web: www.cabadacomercial.com



TARIFA DE PRECIOS

CANALETA		
CODIGO	DESCRIPCIÓN	PVP* (€/UD)
POZ901310	CANALETA EN P.P. GRIS DE 100X13X7.5	7.49
1375CRA	KIT CANALETA 100X13X7.5 + REJILLA GALV CLIP 13X100	14.01
1300KC	KIT CANALETA 100X13X7.5 GRIS + REJILLA CLIP 13X100	12.51
1300KNC	KIT CANALETA 100X13X7.5 NEGRA + REJILLA CLIP 13X100	12.51
1395CRB	KIT CANALETA 100X13X9.5 + REJILLA GALV 13X100 + SYST.BLOCK	16.87
POZ901395TBB	CANALETA TAURUS 13 X 9.5 + REJILLA POLÍMERO B-125 (12,5 tn)	36.80
POZ901335P	CANALETA PEGASUS PLUS ONE 100X35X1000 + REJILLA GRIS	10.38
1351CL	REJILLA PARA CANALETA EN P.P. GRIS C/CLIP DE 100X13	8.65
1351GV	REJILLA PARA CANALETA ESTAMPADA GALVANIZADA 100X13	8.56
POZ901559PE	BLOCK SYSTEM PARA REJILLAS 13	2.55
1313	TAPON TERMINAL PLUS GRIS 13X7.5	1.15
1553PE	TAPON TERMINAL Ø75 13X9.5 "hasta fin existencias"	1.15
POZ901318	PERFIL REFUERZO INOXIDABLE 1.00 "hasta fin existencias"	16.12
ZIN061354I	BLOCK REFUERZO INOX PARA REJILLA "hasta fin existencias"	4.34
POZ901317	PERFIL GALVA REFUERZO CANALETA "hasta fin existencias"	6.58

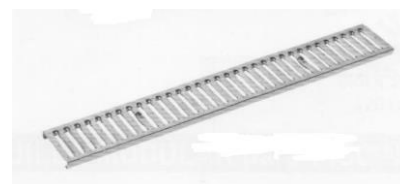
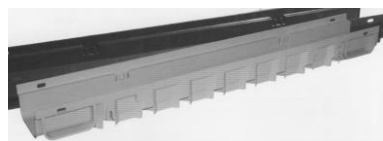

PRODUCTOS DESAGÜE		
ARTICULOS		PVP* (€/UD)
BOC011111	BOCA DESAGÜE REDONDA 100 H24	4.96
BOC021117	ANGULAR PARA DESAG DESAGÜE SALIDA 10	3,72



* IVA NO INCLUIDO

jun-23

OFICINA: C/CARACAS, Nº10 (36203) VIGO – TFNOS. 986421617 / 986420560
 ALMACEN VINCOS: RUA OUTEIRO DO FERRO – POLIG. A PASAXE – VINCOS (GONDOMAR) – TFNO: 986467001
 ALMACEN PONTEAREAS: LOMBA, 81 – AREAS (PONTEAREAS) – TFNO: 986640283
 Mail: info@cabadacomercial.com / tecnicos@cabadacomercial.com / ponteareas@cabadacomercial.com
 Web: www.cabadacomercial.com



ESCALERA ESCAMOTEABLE METÁLICA		
CODIGO	MEDIDAS (mm)	PVP* €/UD
SCA01-590/1	500X800X2800	376.59
SCA01-590/8	500X900X2800	
SCA01-590/2	500X1000X2800	
SCA01-590/80	600X800X2800	
SCA01-590/100	600X1000X2800	
SCA01-590/12	600X1200X2800	
SCA01-590/3	700X800X2800	
SCA01-590/4	700X900X2800	
SCA01-590/5	700X1000X2800	
SCA01-590/6	700X1100X2800	
SCA01-590/7	700X1200X2800	
PELDAÑO PARA ESCALERA		
DE 500 ANCHO 300 MM		69.75
DE 600 ANCHO 320 MM		
DE 700 ANCHO 400 MM		

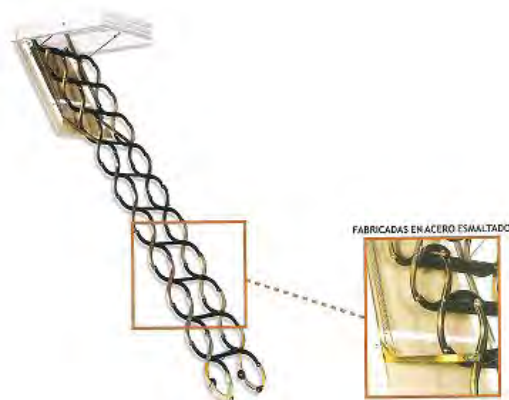

Oreficio Tamaño (d y s)	Ancho Paso (B)	Altura de Trabajo (A)	Altura de Trabajo (A)	Distancia Agujero base de la báscula (C)	Espacio apertura escala (R)
700 x 500	300	3200 - 2200	3200	1400	2100
800 x 500	300	3200 - 2200	3100	1300	2000
900 x 500	300	3200 - 2200	3000	1200	1850
1000 x 500	300	3200 - 2200	2900	1300	1800
800 x 600	320	3200 - 2200	2800	1450	1750
900 x 600	320	3200 - 2200	2700	1650	1700
1000 x 600	320	3200 - 2200	2600	1400	1650
1100 x 600	320	3200 - 2200	2500	1350	1600
1200 x 600	320	3200 - 2200	2400	1000	1650
700 x 700	400	3200 - 2200	2300	1250	1600
800 x 700	400	3200 - 2200	2200	1350	1550
900 x 700	400	3200 - 2200			
1000 x 700	400	3200 - 2200			
1100 x 700	400	3200 - 2200			
1200 x 700	400	3200 - 2200			

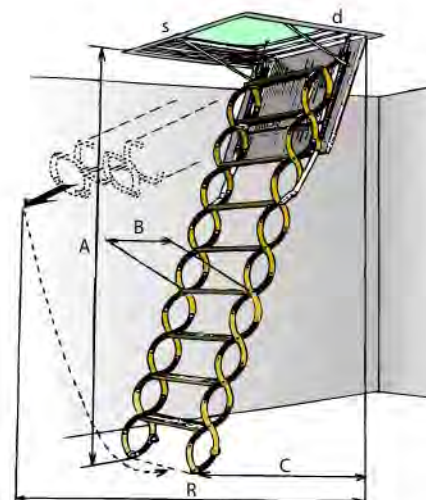

* IVA NO INCLUIDO

feb-23

OFICINA: C/CARACAS, N°10 (36203) VIGO – TFNOS. 986421617 / 986420560
 ALMACEN VINCIOS: RUA OUTEIRO DO FERRO – POLIG. A PASAXE – VINCIOS (GONDOMAR) – TFNO: 986467001
 ALMACEN PONTEAREAS: LOMBA, 81 – AREAS (PONTEAREAS) – TFNO: 986640283
 Mail: info@cabadacomercial.com / tecnicos@cabadacomercial.com / ponteareas@cabadacomercial.com
 Web: www.cabadacomercial.com



TARIFA DE PRECIOS

CONTRAMARCOS ENSAMBLADOS								PVP* (€/UD)
Anchura mm		Alto mm		Grosor mm				
Luz paso "P" +/-	Hueco máx."L"	Luz paso "A" Alto puerta	Hueco máx. "H" Alto estructura	Medida interior "S"	Grueso estructura "E"	Pared Acabada "T"	Espesor máx. Hoja	
ENLUCIDO								
600	1320	2030	2130	69	90	105	55	129,13
700	1520							129,13
800	1720							129,13
900	1920							137,40
1000	2120							177,18
CARTÓN YESO								
600	1320	2030	2130	50	70	100	35	129,13
700	1520							129,13
800	1720							129,13
900	1920							137,40
1000	2120							177,18

ACCESORIOS	
ARTÍCULO	PVP* (€/UD)
KIT UNION ENFOSCADO / CARTÓN YESO	21,45
AMORTIGUADOR (FRENO)	22,75
KIT CARRIL SUELTO	17,20
KIT APERTURA SIMULTÁNEA	61,95

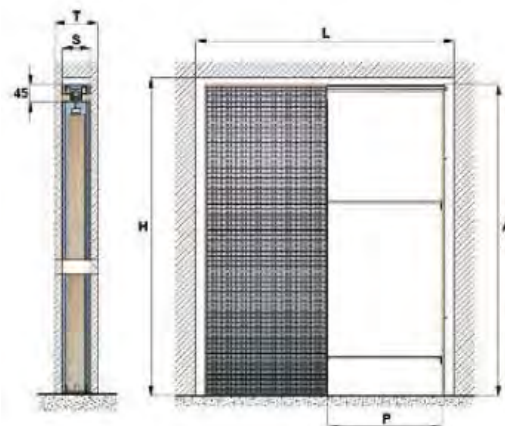

PUERTAS CORREDERAS EXTERNAS		
ARTÍCULO		PVP* (€/UD)
KIT PUERTA CORREDERA EXTERNA A PARED – Aluminio anodizado a pared	2 m	Consultar
	3 m	Consultar
KIT PUERTA CORREDERA EXTERNA A PARED – Madera blanco	2 m	Consultar
KIT PUERTA CORREDERA EXTERNA A PARED – Madera roble	2 m	Consultar
ACCESORIOS		
KIT PINZAS PARA PUERTA DE CRISTAL		Consultar
KIT DE UÑERO PARA PUERTA CORREDERA	Niquel satinado	Consultar
	Latonado pulido	Consultar
KIT CERRADURA CON CONDENA Y DESCONDENA	Niquel satinado	Consultar
	Latonado pulido	Consultar

* IVA NO INCLUIDO

oct-22

OFICINA: C/CARACAS, Nº10 (36203) VIGO – TFNOS. 986421617 / 986420560 FAX: 986483297
 ALMACEN VINCIOS: RUA OUTEIRO DO FERRO – POLIG. A PASAXE – VINCIOS (GONDOMAR) – TFNO: 986467001
 ALMACEN PONTEAREAS: LOMBA, 81 – AREAS (PONTEAREAS) – TFNO: 986640283
 Mail: info@cabadacomercial.com / tecnicos@cabadacomercial.com / ponteareas@cabadacomercial.com
 Web: www.cabadacomercial.com



TARIFA DE PRECIOS

ARTICULOS		APERTURA	MEDIDA	PASO LIBRE	PVP* (€/UD)
PUERTA CORTAFUEGO EI-60	1 HOJA	DERECHA IZQUIERDA REVERSIBLE	900X2050	810	197,76
PUERTA MULTIUSO (Sin homologar)	1 HOJA	DERECHA IZQUIERDA	900X2050	810	159,73

- Otros modelos : consultar precio y plazo de entrega

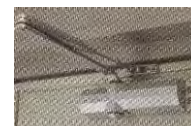

ACCESORIOS			
Consultar precio y plazo de entrega			
MIRILLA (Suelta o Montada)	EI-60	225 MM	PINTADA INOX
		300 MM	PINTADA INOX
	EI-90	225 MM	PINTADA INOX
		300 MM	PINTADA INOX
BARRA ANTIPÁNICO	PUERTA 1 HOJA	PREMONTADA	
	PUERTA 2 HOJAS	SUELTA PREMONTADA	
ELECTRO-IMÁN	PARED NORMAL SUELO		
SELECTOR CIERRE			
SELECTOR CIERRE BÁSICO			
CUADRADILLO			
MEDIA PLACA NYLON – SOLO MANILLA			
BISAGRA SUELTA			
TENSOR BISAGRA			
MARCO TELESCÓPICO EN KIT 90			
BARRA ANTIPÁNICO PUERTA 1 HOJA SUELTA			82,40*
CERRADURA NORMAL			10,25*
MANILLA ESTÁNDAR			18,84*
CIERRA PUERTAS BÁSICO			41,41*

* IVA NO INCLUIDO

* MATERIALES BAJO PEDIDO CON CARGO DE TRANSPORTE ene-24



TARIFA DE PRECIOS

CÓDIGO	ARTICULO	PVP* (€/UD)
20MCA	ESQUINERO MONOCAPA DE 2500 (PVC)	1,77

* Para Revocos. Se utiliza para reforzar las esquinas



CÓDIGO	ARTICULO	PVP* (€/UD)
EP260	ESQUINERO PLÁSTICO DE 2.60 ML	0,84
EP300	ESQUINERO PLÁSTICO DE 3.00 ML	0,97

* Para Revestidos. Se utiliza para reforzar las esquinas



CÓDIGO	ARTICULO	PVP* (€/UD)
2027L	LISTELO CUADRADO BRILLO h.11x2600mm	8,80
2027S	LISTELO CUADRADO SATINADO h.11x2600mm	7,67

* Para azulejo. Se utiliza para proteger y decorar las esquinas en el azulejo.

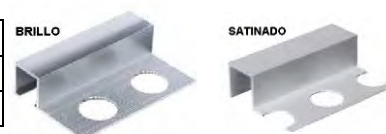

CÓDIGO	ARTICULO	PVP* (€/UD)
PRO202025L	LISTELO ALUMINIO EN T BRILLO h.11x2500mm	5,90
PRO202026L	LISTELO ALUMINIO EN T BRILLO h.20x2500mm	6,60

* Para azulejo y Terminal. Como acabado en suelos, para separar la unión de diferentes pavimentos (cerámica y parquet)



CÓDIGO	ARTICULO	PVP* (€/UD)
ZIN311662BE	GUARDAVIVO ALUMINIO 25X25X2500 mm	5.12

* Para protección o refuerzo de esquinas en la placa de **pladur** y para reformas habituales de interiores

CÓDIGO	ARTICULO	PVP* (€/UD)
JQ	JUNQUILLO MONOCAPA 2 M	1,40

ACCESORIOS AISLAMIENTO SISTEMA SATE

CÓDIGO	ARTICULO	PVP* (€/UD)
ZIN331660BOX	ANGULO VARIABLE C/RED 100X100X25000 mm	34,32

* Angulo con malla de fibra de vidrio. Para dar una resistencia uniforme en todo el aislamiento del edificio, cuando no está a 90°.

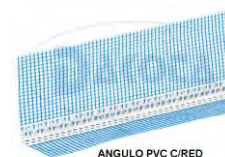

CÓDIGO	ARTICULO	PVP* (€/UD)
ZIN331669RV	ANGULO VIERTEAGUAS SUP. C/RED 100X100X2500mm	5,26
ZIN331669RVS	ANGULO VIERTEAGUAS ESP. C/RED 100X100X2500mm	

* Para protección de las esquinas. Ideal para dinteles de ventanas y cajones de persianas.



* IVA NO INCLUIDO

nov-23



TARIFA DE PRECIOS



Adaptador Tope Profundidad



Adaptador Roscador Varilla

CÓDIGO	ARTICULO	PVP* (€/UD)
333XA3	ADAPTADOR TOPE PROFUNDIDAD	12,80
333XA4	ADAPTADOR ROSCADOR VARILLA M6	13,90



Aislador acústico



CAZOLETA

CÓDIGO	ARTICULO	PVP* (€/UD)
SE105	AISLADOR ACUSTICO SE105	2,16
SE43	AISLADOR ACÚSTICO SE43	3,02
CN	CAZOLETA NIVELADORA (* fijación de un 2º falso techo)	0,33



Alcotana

CÓDIGO	ARTICULO	PVP* (€/UD)
664J10	ALCOTANA MANGO 300 MM	16,02



Tijera para chapa

CÓDIGO	ARTICULO	PVP* (€/UD)
CM4	CARRIL MADERA LISO Nº 4	4,60
CM6	CARRIL MADERA LISO Nº 6	
900L15	CARRIL MEDIA CAÑA Nº 15	6,15
900L16	CARRIL MEDIA CAÑA Nº 16	
900L20	CARRIL MADERA LISO Nº 20	
900D20	CARRIL DENTADO Nº 20	



SERRUCHO



Sierra contornear

CÓDIGO	ARTICULO	PVP* (€/UD)
667P05	TIJERA PARA CHAPA 250 APERTURA RÁPIDA	13,30
664G02	SERRUCHO ESCAYOLISTA 16'' D.NORMAL	10,20
664G06	SIERRA CONTORNEAR 160MM	8,28
701014E	PUNZONADORA PERFILES 2 MANOS ECO	36,00



Broca

CÓDIGO	ARTICULO	PVP* (€/UD)
299069	BROCA SDS- PLUS 8X50 DE 110 MM	4,61
205304	BROCA SDS- PLUS 6X50 DE 110 MM	3,65
909500	BROCA SDS- PLUS 5X50 DE 110 MM	3,50

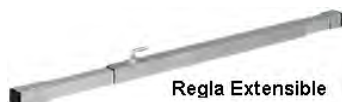

Regla Extensible



REGLA TRAPEZOIDAL



Regla HC

CÓDIGO	ARTICULO	PVP* (€/UD)
304AM2	REGLA EXT ALU MUELLE 180-300	35,14
304AM3	REGLA EXT ALU MUELLE 230-400	40,51
304M02	REGLA EXT GALV MUELLE 180-300	30,03
305T15	REGLA ALU TRAPEZOIDAL 1500MM	17,11
305T20	REGLA ALU TRAPEZOIDAL 2000MM	22,30
305HC2	REGLA H CERRADA ALUMINIO DE 1,50	17,82
R200	REGLA H CERRADA ALUMINIO DE 2.00	23,80
R250	REGLA H CERRADA ALUMINIO DE 2.50	29,75
305TT1	REGLA YESERO ALU DOBLE T 1200MM	12,61

* IVA NO INCLUIDO

ene-25



TARIFA DE PRECIOS



Guión yesero

CÓDIGO	ARTICULO	PVP* (€/UD)
C8	CEPILLO 8 CUCHILLAS (GUION YESERO)	16,85



Escofina para placas y recambio

CÓDIGO	ARTICULO	PVP* (€/UD)
701022	ESCOFINA PLACAS TIPO ESCARABAJO	8,15
701005	REPUESTO ESCOFINA DE PLACAS 250MM	5,60



RASPILLA/CUCHILLA

CÓDIGO	ARTICULO	PVP* (€/UD)
605I01	RASPILLA (CUCHILLA) INOX 140X70	1,61
605IR1	RASPILLA (CUCHILLA) INOX 140X70(1C.RED)	1,83
605I02	RASPILLA (CUCHILLA) LISA INOX 120X60	1,27
605IR2	RASPILLA (CUCHILLA) LISO INOX 120X60(1 C. RED)	1,47

Espátula
Inox. Flexible

CÓDIGO	ARTICULO	PVP* (€/UD)
904S10	ESPATULA INOX FLEX M. GOMA 100 MM	6,58
904S12	ESPATULA INOX FLEX M. GOMA 125 MM	7,88
904S15	ESPATULA INOX FLEX M. GOMA 150 MM	8,46
661003	ESPATULA M.MADERA FLEXIBLE ESCAY	8,58



Espátula M.Madera Flexible

CÓDIGO	ARTICULO	PVP* (€/UD)
LLP	LLANA PLÁSTICO GRIS M. Plástico 520X120	11,42
662TPA	LLANA PLÁSTICO ABS 300X140 M. AM	6,08
663CV1	LLANA INOX 300X120 CURVA M.AME	16,90
663IA3	LLANA INOX 300X140 AFILADA SOLD. M.NORMAL	11,30
66TRIO	LLANA INOX 500X130 AFILADA M. ROJO	19,80
662TPB	LLANA POLIESTIRENO 280X140MM	4,30
663RB2	RASCADOR MONOCAPA 250X144 M.NORMAL	6,87
566512	TALOCHA LIMP. ESPONJA 280X140	3,63
566513	TALOCHA ESPONJA CORTADA 30MM	4,45

TALOCHA LIMP.
ESPONJATaloche
Esponja cortadaLLANA INOX
CURVA 300X120

Llana Inox Afilada



LLANA PARA JUNTAS



LLANA PLÁSTICA

Llana Plástica
ABS

CÓDIGO	ARTICULO	PVP* (€/UD)
904RG2	PALETA ESTR INOX 120 MM M.ERGONOMICO	4,65
904RG6	PALETA ESTR INOX 200 MM M.ERGONOMICO	6,80
904U11	PALETIN ANGULO INT INOX 120X100	14,40
904U02	PALETÍN ANGULO EXT INOX 120X100	



PALETA ESTR. INOX

Paletín
Angulo Inox

* IVA NO INCLUIDO

ene-25



TARIFA DE PRECIOS



FIJACIÓN RÁPIDA
OMEGA DOBLE ROSCA

CÓDIGO	ARTICULO	PVP* (€/UD)
921014	FIJACIÓN RÁPIDA OMEGA M6 D.ROSC	0,25



REMACHE
FLOR

CÓDIGO	ARTICULO	PVP* (€/UD)
914F00	REMACHE FLOR Ø 4.8X35	0,07



Taco Paraguas

CÓDIGO	ARTICULO	PVP* (€/UD)
903T28	TACO PARAGUAS 10X38 MM	0,10



TACO LATÓN

CÓDIGO	ARTICULO	PVP*
090434	TACO LATON N° 4 (200 UD)	8,05 €/CAJA
903S09	TACO LATON N° 6 (100 UD)	10,25 €/CAJA



TACO NYLON

CÓDIGO	ARTICULO	PVP*
903T04	TACO NYLON MULTIUSO 6X30 (200 UD)	5,55 €/CAJA



Taco rápido c/collarín

CÓDIGO	ARTICULO	PVP*
903TC0	TACO RAPIDO CON COLLARIN 6X37 – 200 UD	8,30 €/CAJA



CÓDIGO	ARTICULO	PVP* (€/UD)
03174	TUERCA HEXAGONAL M4	0,04
903S07	TUERCA HEXAGONAL M6 (200 UD)	3,00 €/CAJA



Varilla Roscada



CÓDIGO	ARTICULO	PVP* (€/UD)
09584	VARILLA ROSCADA Ø 4	0,40
186003	VARILLA ROSCADA Ø 6	0,60
ARH	ARANDELA HIERRO DE 30 MM	0,08



MANGUITO HEX.

CÓDIGO	ARTICULO	PVP* (€/UD)
903S05	MANGUITO M-6X20 HEXAGONAL	0,20



GRAPA VIGUETA PARA
VARILLA

CÓDIGO	ARTICULO	PVP* (€/UD)
921022	GRAPA VIGUETA PARA VARILLA M6 1.5-4MM	0,70
921002	GRAPA VIGUETA PARA VARILLA M6 4-10MM	



ALISADOR ESPONJA

CÓDIGO	ARTICULO	PVP* (€/UD)
560507	ALISADOR ESPONJA 280X140	6,67

* IVA NO INCLUIDO

ene-25



TARIFA DE PRECIOS

			PVP* (€/UD)
CRUCETAS PARA AZULEJOS EN "CRUZ"			
TER041201X	CRUCETAS 1 MM	200 UD/Bolsa	1,80
TER041202X	CRUCETAS 2 MM	200 UD/Bolsa	1,80
TER041203X	CRUCETAS 3 MM	200 UD/Bolsa	1,80
TER041205	CRUCETAS 5 MM	200 UD/Bolsa	1,80
TER041207	CRUCETAS 7 MM	200 UD/Bolsa	2,43
TER041200	CRUCETAS 10 MM	200 UD/Bolsa	3,09



			PVP* (€/UD)
NIVELANTE CUÑA, PINZA Y ELEMENTOS BASE TWO LEVEL			
TER04429B100	NIVELANTE CUÑA 100 UD	100 UD/Bolsa	7,88
TER044209P	PINZA PLASTICA PARA NIVELANTE CUÑA	1 UD	12,58

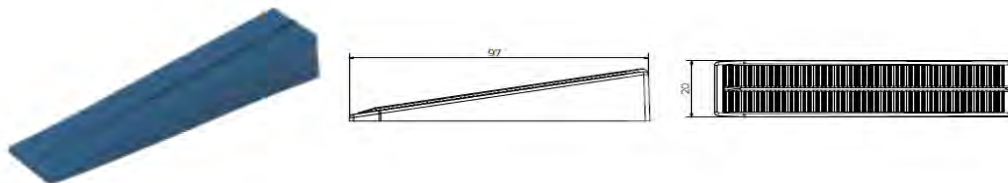

TER044209EB05	NIVELANTE BASE 0.5 MM	250 UD/Bolsa	9,56
TER044209EB1	NIVELANTE BASE 1.0 MM	250 UD/Bolsa	9,56
TER044209EB2	NIVELANTE BASE 1.5 MM	250 UD/Bolsa	9,56



0,5 mm 1 mm 1,5 mm Plastic Plier

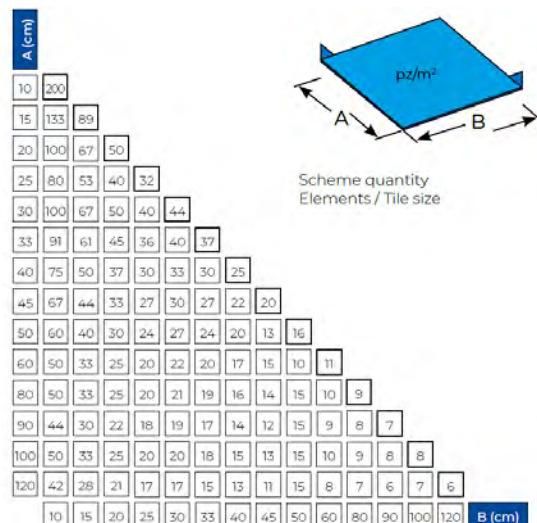
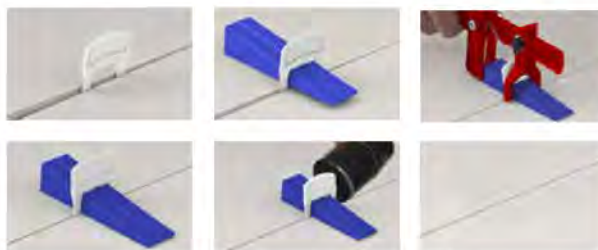

* IVA NO INCLUIDO

dic-24



Cabada

EXCLUSIVAS PARA LA CONSTRUCCIÓN



TARIFA DE PRECIOS

ARTICULO			PVP* (€/UD)
10043065	ANCLAJE QUÍMICO EV1 300 ML GRIS CLARO		5,00 €
OCN	ESPUMA MULTIUSOS ORBAFOAM **NUEVOS FORMATOS**	CÁNULA (670ml)	4,21 €
OPN		PISTOLA (700 ml)	4,36 €
OF60	ORBAFOAM FIJACION 60 SEG		10,62 €
PU50	SINTEX PU-50 300 ML BLANCO, GRIS, MARRÓN Y NEGRO		3,60 €
MS35	SINTEX MS-35 300 ML GRIS, NEGRO Y BLANCO		5,05 €
OPR	ORBAFOAM TEJAS PARA PISTOLA ROJO TEJA		5,65 €* Espuma adhesiva de poliuretano para pegar y colocar tejas. Aplicación con cánula manual o pistola. Para el pegado de todo tipo de tejas a superficies de hormigón, mortero, madera o fibrocemento. Adherencia fuerte y duradera a la mayoría de los materiales de construcción. Baja expansión.
OPR650	ORBAFOAM TEJAS PARA PISTOLA ROJO TEJA 650 ML		5,39 €
OCR	ORBAFOAM TEJAS PARA CÁNULA ROJO TEJA		5,56 €* 5,31 €
OCR650	ORBAFOAM TEJAS PARA CÁNULA ROJO TEJA 650 ML		
PEC	PISTOLA ESPUMA CALIBER 30		11,95 €
OL	ORBAFOAM LIMPIADOR ESPUMA 500 ML		6,35 €
MST	SINTEX MS TRANSPARENTE 280 ML		5,27 €

***Hasta final de existencias**



* IVA NO INCLUIDO

nov-24

OFICINA: C/CARACAS, N°10 (36203) VIGO – TFNOS. 986421617 / 986420560
 ALMACEN VINCIOS: RUA OUTEIRO DO FERRO – POLIG. A PASAXE – VINCIOS (GONDOMAR) – TFNO: 986467001
 ALMACEN PONTEAREAS: LOMBA, 81 – AREAS (PONTEAREAS) – TFNO: 986640283
 Mail: info@cabadacomercial.com / tecnicos@cabadacomercial.com / ponteareas@cabadacomercial.com
 Web: www.cabadacomercial.com

ANEXO – I –



TARIFA DE PRECIOS

ARIDOS / MORTEROS

	ARTICULOS	PVP* (€/ud)
CGC	CEMENTO CARRAL II/B-L 42.5R 25KG	4,55
A	ARENA ENTREFINA 0/4 SACO ± 900K	30,00
AF	ARENA FINA 0/2 SACO ± 1000 KG	30,00
SG	SACO GRAVA 10/20	30,00
MM75	MORTERO MAMPOSTERÍA M 7.5 GRIS 25 KG	2,97
HORSEC25	HORMIGÓN SECO 25 KG	4,40



	ARTICULOS	PVP* (€/ud)
CA	CAPAZO DE ARENA 55/60 KG	2,50
PC	PALET CEMENTO Y MORTERO (se abonará por el mismo importe a su devolución)	15,00
9900001	SACA BIG BAG	4,05

* IVA NO INCLUIDO

feb-25

OFICINA: C/CARACAS, N°10 (36203) VIGO – TFNOS. 986421617 / 986420560
ALMACEN VINCIOS: RUA OUTEIRO DO FERRO – POLIG. A PASAXE – VINCIOS (GONDOMAR) – TFNO: 986467001
ALMACEN PONTEAREAS: LOMBA, 81 – AREAS (PONTEAREAS) – TFNO: 986640283
Mail: info@cabadacomercial.com / tecnicos@cabadacomercial.com / ponteareas@cabadacomercial.com
Web: www.cabadacomercial.com

ANEXO – II –



TARIFA DE PRECIOS

ARTICULO	PALET	PVP* €
PIEDRA MUSGO FINA 8/9 CM	±10 FILAS	134,00
PIEDRA MUSGO FINA 8/9 CM	± 7 FILAS	120,00



* IVA NO INCLUIDO

mar-25

OFICINA: C/CARACAS, Nº10 (36203) VIGO – TFNOS. 986421617 / 986420560 FAX: 986483297
ALMACEN VINCOS: RUA OUTEIRO DO FERRO – POLIG. A PASAXE – VINCOS (GONDOMAR) – TFNO: 986467001
ALMACEN PONTEAREAS: LOMBA, 81 – AREAS (PONTEAREAS) – TFNO: 986640283
Mail: info@cabadacomercial.com / tecnicos@cabadacomercial.com / ponteareas@cabadacomercial.com
Web: www.cabadacomercial.com

ANEXO - III